

# h10

---

CATALOGUE / PRICE LIST

---

2020/2021

# INDEX

<b>DUST BINS</b>	04
<b>WC BRUSHES</b>	18
<b>DISABLED SERIES</b>	21
<b>LINEAR SHOWER CHANELS</b>	27
<b>FLOOR DRAINS</b>	67
<b>SHOWER SETS</b>	96
<b>DRAINAGE CHANNELS</b>	104
<b>ACCESSORIES</b>	124
<b>INOX CERAMIC PROFILES</b>	150

# ICON EXPLANATION



Side Outlet



Vertical Outlet



Indoor



Outdoor



Hot and cold working areas



Vet area



Using with mesh



Using textile membrane



Using with bitum membrane



Low density flow rate



High density Flow rate



Lock system

# DUST BINS

# h10



## STANDARD

Code	Diameter	Length	Quality		Price \$
------	----------	--------	---------	--	----------

### SS 430

4501.1825S.430.03	3 L	Ø 21	22 cm	SS. 430	8	9,45
4501.2028S.430.05	5 L	Ø 21	26 cm	SS. 430	8	10,57
4501.2035S.430.08	8 L	Ø 21	35 cm	SS. 430	6	12,78
4501.2435S.430.12	12 L	Ø 25	35 cm	SS. 430	6	14,45
4501.2444S.430.16	16 L	Ø 25	44 cm	SS. 430	4	18,33
4501.3135S.430.20	20 L	Ø 31	36 cm	SS. 430	4	25,00
4501.3144S.430.30	30 L	Ø 31	45 cm	SS. 430	4	30,57
4501.3163S.430.40	40 L	Ø 31	63 cm	SS. 430	4	37,78

### SS 304

4501.1825S.304.03	3 L	Ø 21	22 cm	SS. 304	8	11,67
4501.2028S.304.05	5 L	Ø 21	26 cm	SS. 304	8	13,33
4501.2035S.304.08	8 L	Ø 21	35 cm	SS. 304	6	15,57
4501.2435S.304.12	12 L	Ø 25	35 cm	SS. 304	6	18,33

### СО СТАНДАРТНОЙ ПЕДАЛЮ

بدواسمة مستوى

## SOFT CLOSER

Code	Diameter	Length	Quality		Price \$
------	----------	--------	---------	--	----------

### SS 430

4501.1825Y.430.03	3 L	Ø 21	22 cm	SS. 430	8	10,57
4501.2028Y.430.05	5 L	Ø 21	26 cm	SS. 430	8	12,23
4501.2035Y.430.08	8 L	Ø 21	35 cm	SS. 430	6	13,90
4501.2435Y.430.12	12 L	Ø 25	35 cm	SS. 430	6	15,57
4501.2444Y.430.16	16 L	Ø 25	44 cm	SS. 430	4	20,00
4501.3135Y.430.20	20 L	Ø 31	36 cm	SS. 430	4	25,00
4501.3144Y.430.30	30 L	Ø 31	45 cm	SS. 430	4	28,90
4501.3163Y.430.40	40 L	Ø 31	63 cm	SS. 430	4	35,57

### SS 304

4501.1825Y.304.03	3 L	Ø 21	22 cm	SS. 304	8	13,90
4501.2028Y.304.05	5 L	Ø 21	26 cm	SS. 304	8	15,57
4501.2035Y.304.08	8 L	Ø 21	35 cm	SS. 304	6	17,78
4501.2435Y.304.12	12 L	Ø 25	35 cm	SS. 304	6	21,12

### мягкие близко мусорное ведро

إغلاق بطيء

## MICRO

Code	Diameter	Length	Quality		Price \$
------	----------	--------	---------	--	----------

### SS 430

4501.1725M.430.03	3 L	Ø 17	24 cm	SS. 430	8	7,23
4501.1825M.430.05	5 L	Ø 21	22 cm	SS. 430	8	8,33

### С МИКРО ПЕДАЛЮ

بدواسمة ميكرو



# DUST BINS

# h10



## PRACTICAL COVER

Code	Diameter	Length	Quality		Price \$
------	----------	--------	---------	--	----------

### SS 430

4513.0000S.430.05	5 L	Ø 21	26 cm	SS. 430	8	17,50
4513.0000S.430.08	8 L	Ø 21	32 cm	SS. 430	8	18,53
4513.0000S.430.12	12 L	Ø 25	34 cm	SS. 430	6	22,35
4513.0000S.430.16	16 L	Ø 25	36,5 cm	SS. 430	6	26,88
4513.0000S.430.20	20 L	Ø 25	44,5 cm	SS. 430	6	28,58
4513.0000S.430.27	27 L	Ø 25	57 cm	SS. 430	6	30,65
4513.0000S.430.32	32 L	Ø 31	45 cm	SS. 430	4	34,27
4513.0000S.430.45	45 L	Ø 31	56 cm	SS. 430	4	36,80

**ПРАКТИЧНАЯ КРЫШКА**  
غطاء عملي

## PRACTICAL RING

Code	Diameter	Length	Quality		Price \$
------	----------	--------	---------	--	----------

### SS 430

4514.0000S.430.05	5 L	Ø 21	26 cm	SS. 430	8	13,77
4514.0000S.430.08	8 L	Ø 21	32 cm	SS. 430	8	14,80
4514.0000S.430.12	12 L	Ø 25	34 cm	SS. 430	6	17,95
4514.0000S.430.16	16 L	Ø 25	36,5 cm	SS. 430	6	22,05
4514.0000S.430.20	20 L	Ø 25	44,5 cm	SS. 430	6	24,18
4514.0000S.430.27	27 L	Ø 25	57 cm	SS. 430	6	26,53
4514.0000S.430.32	32 L	Ø 31	45 cm	SS. 430	4	29,05
4514.0000S.430.45	45 L	Ø 31	56 cm	SS. 430	4	31,58

**ПРАКТИЧЕСКОЕ КОЛЬЦО**  
بطوق عملي

## WITHOUT COVER

Code	Diameter	Length	Quality		Price \$
------	----------	--------	---------	--	----------

### SS 430

4503.1823S.430.03	3 L	Ø 21	20,5 cm	SS. 430	8	6,05
4503.2026S.430.05	5 L	Ø 21	24 cm	SS. 430	8	6,72
4503.2033S.430.08	8 L	Ø 21	33 cm	SS. 430	6	8,25
4503.2433S.430.12	12 L	Ø 25	33 cm	SS. 430	6	9,68
4503.2441S.430.16	16 L	Ø 25	42 cm	SS. 430	4	12,72

### SS 304

4503.1823S.304.03	3 L	Ø 21	20,5 cm	SS. 304	8	8,15
4503.2026S.304.05	5 L	Ø 21	24 cm	SS. 304	8	9,23
4503.2035S.304.08	8 L	Ø 21	33 cm	SS. 304	6	11,27
4503.2435S.304.12	12 L	Ø 25	33 cm	SS. 304	6	13,90

**БЕЗ КРЫШКИ**  
بدون غطاء

## WITH RING

Code	Diameter	Length	Quality		Price \$
------	----------	--------	---------	--	----------

### SS 430

4504.1924S.430.03	3 L	Ø 21	20,5 cm	SS. 430	8	10,08
4504.2127S.430.05	5 L	Ø 21	24 cm	SS. 430	8	10,77
4504.2034S.430.08	8 L	Ø 21	33 cm	SS. 430	6	12,37
4504.2434S.430.12	12 L	Ø 25	33 cm	SS. 430	6	14,12
4504.2442S.430.16	16 L	Ø 25	42 cm	SS. 430	4	17,08

### SS 304

4504.1924S.304.03	3 L	Ø 21	20,5 cm	SS. 304	8	12,63
4504.2127S.304.05	5 L	Ø 21	24 cm	SS. 304	8	13,68
4504.2034S.304.08	8 L	Ø 21	33 cm	SS. 304	6	16,07
4504.2434S.304.12	12 L	Ø 25	33 cm	SS. 304	6	18,80

**С ОБОДКОМ**  
مع طوق



# DUST BINS

h10

NEW!



## STANDARD PAINTED DUST BIN

Code	Color	Diameter	Length		Price \$
------	-------	----------	--------	--	----------

### PAINTED 3 LITER

4501.1825S.101.03	WHITE	3 L	Ø 21	23 cm	8	9,62
4501.1825S.102.03	BLACK	3 L	Ø 21	23 cm	8	9,62
4501.1825S.103.03	PINK	3 L	Ø 21	23 cm	8	9,62
4501.1825S.104.03	RED	3 L	Ø 21	23 cm	8	9,62
4501.1825S.105.03	PURPLE	3 L	Ø 21	23 cm	8	9,62

### PAINTED 5 LITER

4501.2028S.101.05	WHITE	5 L	Ø 21	26 cm	8	9,98
4501.2028S.102.05	BLACK	5 L	Ø 21	26 cm	8	9,98
4501.2028S.103.05	PINK	5 L	Ø 21	26 cm	8	9,98
4501.2028S.104.05	RED	5 L	Ø 21	26 cm	8	9,98
4501.2028S.105.05	PURPLE	5 L	Ø 21	26 cm	8	9,98

### PAINTED 12 LITER

4501.2435S.101.12	WHITE	12 L	Ø 25	35 cm	6	17,42
4501.2435S.102.12	BLACK	12 L	Ø 25	35 cm	6	17,42
4501.2435S.103.12	PINK	12 L	Ø 25	35 cm	6	17,42
4501.2435S.104.12	RED	12 L	Ø 25	35 cm	6	17,42
4501.2435S.105.12	PURPLE	12 L	Ø 25	35 cm	6	17,42

NEW!



## COUNTERTOP SOAP DISPENSER

Code	Color	Diameter	Length		Price \$
------	-------	----------	--------	--	----------

### STAINLESS SS 430

4411.17.718.1		Ø 7	17 cm	20	43.40
---------------	--	-----	-------	----	-------

### PAINTED

4711.18.71.B	WHITE	Ø 7	17 cm	20	40.00
4711.18.71.S	BLACK	Ø 7	17 cm	20	40.00
4711.18.71.P	PINK	Ø 7	17 cm	20	40.00
4711.18.71.K	RED	Ø 7	17 cm	20	40.00
4711.18.71.M	PURPLE	Ø 7	17 cm	20	40.00

NEW!



## TOOTH BRUSH HOLDER

Code	Color	Diameter	Length		Price \$
------	-------	----------	--------	--	----------

### STAINLESS SS 430

4711.22.711.1		Ø 7	11 cm	8	26.70
---------------	--	-----	-------	---	-------

### PAINTED

4711.22.711.B	WHITE	Ø 7	11 cm	8	23.40
4711.22.711.S	BLACK	Ø 7	11 cm	8	23.40
4711.22.711.P	PINK	Ø 7	11 cm	8	23.40
4711.22.711.K	RED	Ø 7	11 cm	8	23.40
4711.22.711.M	PURPLE	Ø 7	11 cm	8	23.40

# DUST BINS

h10



STANDARD

Code	Color	Icon	Price \$
SS 430 2 IN 1 SET			
ST.0102.430.P	CHROME	8	11,95



PAINTED 2 IN 1 SET

ST.0402.101.B	WHITE	8	16,95
ST.0302.102.S	BLACK	8	16,95
ST.0202.103.P	PINK	8	16,95
ST.0102.104.K	RED	8	16,95
ST.0502.105.M	PURPLE	8	16,95



STANDARD

Code	Color	Icon	Price \$
SS 430 4 IN 1 SET			
ST.0104.430.P	-	1	19,58



PAINTED 4 IN 1 SET

ST.0404.101.B	WHITE	1	24,73
ST.0304.102.S	BLACK	1	24,73
ST.0204.103.P	PINK	1	24,73
ST.0104.104.K	RED	1	24,73
ST.0504.105.M	PURPLE	1	24,73

# DUST BINS

# h10



## SWIVEL COVER

Code	Size	Quality		Price \$
------	------	---------	--	----------

### SS 430

4508.1528S.430.07	7 L	15x17x28 cm	SS. 430	1	17,33
4508.1839S.430.11	11 L	18x20x39 cm	SS. 430	1	22,48
4508.1850S.430.16	16 L	18x20x50 cm	SS. 430	1	28,28
4508.2448S.430.25	25 L	24x28x48 cm	SS. 430	1	42,33
4508.2463S.430.36	36 L	24x28x63 cm	SS. 430	1	51,08
4508.3055S.430.45	45 L	30x35x55 cm	SS. 430	1	56,18
4508.3061S.430.54	54 L	30x35x61 cm	SS. 430	1	63,12
4508.3089S.430.80	80 L	30x35x89 cm	SS. 430	1	80,62

### SS 304

4508.1528S.304.07	7 L	15x17x28 cm	SS. 304	1	23,98
4508.1839S.304.11	11 L	18x20x39 cm	SS. 304	1	31,95
4508.1850S.304.16	16 L	18x20x50 cm	SS. 304	1	40,15
4508.2448S.304.25	25 L	24x28x48 cm	SS. 304	1	62,62
4508.2463S.304.36	36 L	24x28x63 cm	SS. 304	1	75,10
4508.3055S.304.45	45 L	30x35x55 cm	SS. 304	1	84,35
4508.3061S.304.54	54 L	30x35x61 cm	SS. 304	1	94,20
4508.3089S.304.80	80 L	30x35x89 cm	SS. 304	1	119,37

### КАЧАЮЩАЯСЯ КРЫШКА

غطاء هزاز

## STRAIGHT COVER

Code	Diameter	Height	Quality		Price \$
------	----------	--------	---------	--	----------

### SS 430

4513.2860S.430.0	Ø 27	59 cm	SS. 430	4	22,23
------------------	------	-------	---------	---	-------

### ПЛОСКАЯ КРЫШКА

غطاء مسطح

## CAMBER COVER

Code	Diameter	Height	Quality		Price \$
------	----------	--------	---------	--	----------

### SS 430

4512.2867S.000.00	Ø 27	62 cm	SS. 430	4	21,67
-------------------	------	-------	---------	---	-------

## BUILT-IN CUPBOARD

Code	Diameter	Height	Quality		Price \$
------	----------	--------	---------	--	----------

### SS 430

4512.1240S.430.16	Ø 25	29 cm	SS. 430	12	14,77
-------------------	------	-------	---------	----	-------





# DUST BINS

h10



## OFFICE TYPE

Code	Diameter	Height	Quality		Price \$
------	----------	--------	---------	--	----------

DKP

4505.2430S.000.00	Ø 24	30 cm	Dkp	10	7,20
-------------------	------	-------	-----	----	------

**ТИП ОФИСА**  
نوع مكنتي شبكي



## OFFICE TYPE PAINTED

Code	Diameter	Height	Quality		Price \$
------	----------	--------	---------	--	----------

DKP

4505.2330S.000.00	Ø 23	30 cm	Dkp	10	5,77
-------------------	------	-------	-----	----	------

**ОФИСНОГО ТИПА, ОКРАШЕННЫЙ**  
نوع مكنتي مصبوع



## OFFICE TYPE PERFORATED

Code	Diameter	Height	Quality		Price \$
------	----------	--------	---------	--	----------

DKP

4505.2330D.000.00	Ø 23	30 cm	Dkp	10	6,48
-------------------	------	-------	-----	----	------

**ТИП ОФИСНЫЙ ПЕРФОРИРОВАННЫЙ**  
نوع مكنتي منقوب



## FIREPROOF

Code	Diameter	Height	Quality		Price \$
------	----------	--------	---------	--	----------

SS 430

4507.2125S.430.08	8 L	Ø 21	25 cm	SS. 430	8	12,78
-------------------	-----	------	-------	---------	---	-------

**НЕГОРЮЧЕЕ**  
مقاوم للاحتراق



## OFFICE TYPE

Code	Diameter	Height	Quality		Price \$
------	----------	--------	---------	--	----------

SS 430

4506.2529S.000.00	Ø 21	24 cm	SS. 430	8	9,45
-------------------	------	-------	---------	---	------

**ОФИСНОГО ТИПА**  
نوع مكنتي

# ASHTRAYS

h10



## GRIDDED COLUMN ASHTRAY

Code	Diameter	Height	Quality		Price \$
SS 430					
4513.2860I.430.0	Ø 26	60 cm	S.S. 430	6	22,07

**ЦИЛИНДРИЧЕСКАЯ ПЕПЕЛЬНИЦА С РЕШЕТКОЙ, СТАНДАРТНАЯ**  
منفضة سجائر بعمود شبكي



## STANDARD COLUMN ASHTRAY

Code	Diameter	Height	Quality		Price \$
SS 430					
4418.1960S.430.00	Ø 19	60 cm	S.S. 430	8	16,40
4418.2160S.430.00	Ø 21	60 cm	S.S. 430	8	17,78
4418.2560S.430.00	Ø 25	60 cm	S.S. 430	6	21,12
4418.2860S.430.00	Ø 28	60 cm	S.S. 430	4	23,90

**ЦИЛИНДРИЧЕСКАЯ ПЕПЕЛЬНИЦА**  
منفضة سجائر قياسية



## CHAMPANGE TYPE ASHTRAY

Code	Diameter	Height	Quality		Price \$
SS 430					
4418.2671S.430.00	Ø 26	61 cm	S.S. 430	4	21,12

**ПЕПЕЛЬНИЦА ДЛЯ ХОЛЛА**  
منفضة السجائر لوبي



## CHAMPANGE ASH CAN

Code	Diameter	Height	Quality		Price \$
SS 430					
4418.3165S.430.00	8 L Ø 32	61 cm	S.S. 430	4	21,12

**ПЕПЕЛЬНИЦА ЧАША**  
منفضة السجائر شامباني

# ASHTRAYS

h10



## PIPE TYPE ASHTRAY

Code	Diameter	Height	Quality		Price \$
SS 304					
4418.1182S.304.00	Ø 110	83 cm	SS. 304	4	94,45



## NARROW PIPE TYPE ASHTRAY

Code	Diameter	Height	Quality		Price \$
SS 304					
4418.2582S.304.00	Ø 110	82 cm	SS. 304	4	47,24



## HOME TYPE

Code	Diameter	Height	Quality		Price \$
SS 304					
4419.0709M.304.00	Ø 70	9 cm	SS. 304	4	8,84
4419.0712M.304.00	Ø 70	12 cm	SS. 304	4	11,07



U TYPE BIN

Code	Length		Price \$
DKP			
4505.5047S.000.00	45x72,5x42 cm	1	69,52

**СТАЛЬ ДКП ТИП U**  
 نوع U من DKP



TUBE TYPE BIN

Code	Length		Price \$
DKP			
4539.5049U.000.00	45x117 cm	-	58,97

**ЛИСТОВАЯ СТАЛЬ (ДКП) ТРУБНОГО ТИПА**  
 نوع أنبوب من DKP



BIN WITH CAP

Code	Length		Price \$
DKP			
4539.5048S.000.00	45x115x45 cm	1	66,80

**С ШАПКОЙ ДКП**  
 سلة DKP بقبحة





## PROFILE BIN

Code	Length		Price \$
------	--------	--	----------

### DKP

4505.5045S.000.00	45x100 cm	1	60,17
-------------------	-----------	---	-------

**ПРОФИЛЬ ИЗ ДКП**  
نوع بروفيل DKP



## STAINLESS OUTDOOR BIN

Code	Length	Quality		Price \$
------	--------	---------	--	----------

### S.S. 304

4518.5099S.000.00	45x115x45 cm	S.S. 304	1	150,00
-------------------	--------------	----------	---	--------

**НЕРЖАВЕЙКА, САД**  
للحديقة مقاوم للصدأ



## STAINLESS OUTDOOR BIN

Code	Length	Quality		Price \$
------	--------	---------	--	----------

### S.S. 304

4518.50745.000.00	45x72,5x42 cm	S.S. 304	1	150,00
-------------------	---------------	----------	---	--------

**НЕРЖАВЕЙКА, САД**  
للحديقة مقاوم للصدأ

# RECYCLING DUST BINS

h10



## SQUARE RECYCLING DUST BIN 3 IN 1

Code	Length	Quality	Price \$
SS 430			
AT101.3430.P	1110x355x910	SS. 430	273,83
SS 304			
AT101.3304.P	1110x355x910	SS. 304	371,47

## SQUARE RECYCLING DUST BIN 4 IN 1

Code	Length	Quality	Price \$
SS 430			
AT101.4430.P	148x35,5x91 cm	SS. 430	360,02
SS 304			
AT101.4304.P	148x35,5x91 cm	SS. 304	490,20



## SQUARE PAINTED RECYCLING DUST BIN 3 IN 1

Code	Length	Quality	Price \$
DKP			
AT101.3100.B	111x35,5x91 cm	DKP	195,97

## SQUARE PAINTED RECYCLING DUST BIN 4 IN 1

Code	Length	Quality	Price \$
DKP			
AT101.4100.B	148x35,5x91 cm	DKP	256,20



# RECYCLING DUST BINS

h10



## SWIVEL COVER RECYCLING DUST BIN 3 IN 1

Code	Length	Quality	Price \$
------	--------	---------	----------

SS 430

AT102.3430.P	111x35,5x91 cm	S.S. 430	273,93
--------------	----------------	----------	--------

SS 304

AT102.3304.P	111x35,5x91 cm	S.S. 304	371,47
--------------	----------------	----------	--------

## SWIVEL COVER RECYCLING DUST BIN 4 IN 1

Code	Length	Quality	Price \$
------	--------	---------	----------

SS 430

AT102.4430.P	148x35,5x91 cm	S.S. 430	360,02
--------------	----------------	----------	--------

SS 304

AT102.4304.P	148x35,5x91 cm	S.S. 304	490,20
--------------	----------------	----------	--------



## SWIVEL PAINTED COVER RECYCLING DUST BIN 3 IN 1

Code	Length	Quality	Price \$
------	--------	---------	----------

DKP

AT102.3100.B	111x35,5x91 cm	S.S. 430	195,97
--------------	----------------	----------	--------

## SWIVEL PAINTED COVER RECYCLING DUST BIN 4 IN 1

Code	Length	Quality	Price \$
------	--------	---------	----------

DKP

AT102.4100.B	148x35,5x91 cm	S.S. 430	256,20
--------------	----------------	----------	--------



# RECYCLING DUST BINS

h10

NEW!



DOME COVER RECYCLING DUST BIN 3 IN 1

Code	Length	Quality	Price \$
SS 430			
AT103.3430.P	111x35,5x70	SS. 430	119,47



DOME COVER RECYCLING DUST BIN 4 IN 1

Code	Length	Quality	Price \$
SS 430			
AT103.4430.P	148x35,5x70 cm	SS. 430	149,72

NEW!



PAINTED DOME COVER RECYCLING DUST BIN

Code	Length	Quality	Price \$
3 IN 1			
AT103.3100.B	111x35,5x70 cm	DKP	134,87
4 IN 1			
AT103.4100.B	148x35,5x70 cm	DKP	174,73



# RECYCLING DUST BINS

h10

**NEW!**



RING COVER RECYCLING DUST BIN 3 IN 1

Code	Length	Quality	Price \$
SS 430			
ATI04.3430.P	1110x400x700	SS. 430	149,17



RING COVER RECYCLING DUST BIN 4 IN 1

Code	Length	Quality	Price \$
SS 430			
ATI04.4430.P	1480x400x700	SS. 430	193,80

**NEW!**



PRACTICAL COVER RECYCLING DUST BIN 3 IN 1

Code	Length	Quality	Price \$
SS 430			
ATI05.3430.P	1110x400x700	SS. 430	150,47



PRACTICAL COVER RECYCLING DUST BIN 4 IN 1

Code	Length	Quality	Price \$
SS 430			
ATI05.4430.P	1480x400x700	SS. 430	199,00

## MICRO FLAT COVER

Code	Diameter	Height	Quality	 Price \$
KF01.430K.36	Ø 8	H.36 cm	S.S. 430	20 3,90

Плоская крышка щетки для унитаза  
غطاء مسطح

## FLAT COVER

Code	Diameter	Height	Quality	 Price \$
KF05.430K.36	Ø 8	H.36 cm	S.S. 430	20 4,45
KF06.304K.36	Ø 8	H.36 cm	S.S. 304	20 5,28
KF07.304K.36	Ø 9	H.36 cm	S.S. 304	20 5,70
KF08.430K.36	Ø 9	H.36 cm	S.S. 430	20 4,73

## HANGERS

KF15.430K.36	Ø 8	H.36 cm	S.S. 430	20 5,00
KF16.304K.36	Ø 8	H.36 cm	S.S. 304	20 5,82
KF17.304K.36	Ø 9	H.36 cm	S.S. 304	20 6,40
KF18.430K.36	Ø 9	H.36 cm	S.S. 430	20 5,28

## CAMBER COVER

Code	Diameter	Height	Quality	 Price \$
KF25.430K.36	Ø 8	H.38 cm	S.S. 430	20 4,73
KF26.304K.36	Ø 8	H.38 cm	S.S. 304	20 5,73
KF27.304K.36	Ø 9	H.38 cm	S.S. 304	20 6,62
KF28.430K.36	Ø 9	H.38 cm	S.S. 430	20 5,42

## HANGERS

KF35.430K.36	Ø 8	H.38 cm	S.S. 430	20 5,50
KF36.304K.36	Ø 8	H.38 cm	S.S. 304	20 6,50
KF37.304K.36	Ø 9	H.38 cm	S.S. 304	20 7,23
KF38.430K.36	Ø 9	H.38 cm	S.S. 430	20 6,12

## PERFORATED FLAT COVER

Code	Diameter	Height	Quality	 Price \$
KF46.430K.36	Delikli Ø 9	H.36 cm	S.S. 430	20 5,15
KF45.304K.36	Delikli Ø 9	H.36 cm	S.S. 304	20 6,25

## HANGERS

KF48.430K.36	D.Askılı Ø 9	H.36 cm	S.S. 430	20 5,57
KF47.304K.36	D.Askılı Ø 9	H.36 cm	S.S. 304	20 6,67



Плоская крышка щетки для унитаза  
غطاء مسطح  
висели плоская крышка щетки для унитаза  
غطاء مسطح معلق



круглая крышка щетка для унитаза  
غطاء محدب  
висели круглая крышка щетка для унитаза  
غطاء محدب معلق



перфорированная крышка плоская щетка для унитаза  
غطاء مسطح متقوية  
висели перфорированная крышка плоская щетка для унитаза  
غطاء مسطح متقوية معلق

# FIRÇALIKLAR

# h10

## PYRAMID LUX

Code	Diameter	Height	Quality	Price \$
------	----------	--------	---------	----------

KF55.304K.36	Ø 8	H.39 cm	S.S. 304	20	8,33
--------------	-----	---------	----------	----	------

## HANGERS

KF56.304K.36	Ø 8	H.39 cm	S.S. 304	20	9,17
--------------	-----	---------	----------	----	------

**ПИРАМИДА ЛЮКС**  
لوكن شكل هرمي

**ВИСЕЛИ ПИРАМИДА ЛЮКС**  
لوكن شكل هرمي معلق

## WITH BIYE

Code	Diameter	Height	Quality	Price \$
------	----------	--------	---------	----------

KF61.304K.36	Ø 9	H.39,5 cm	S.S. 304	20	11,67
--------------	-----	-----------	----------	----	-------

**НАПОЛЬНЫЙ ЕРШИК**  
فرشاة مرحاض بقضييب

## SMART COVER

Code	Diameter	Height	Quality	Price \$
------	----------	--------	---------	----------

## ROUND

KF62.304K.36	Ø 8.5	H.37 cm	S.S. 304	20	15,35
--------------	-------	---------	----------	----	-------

## SQUARE

KF63.304K.36	37x8x8 cm		S.S. 304	20	24,45
--------------	-----------	--	----------	----	-------

**КРЫШКА С ДОВОДЧИКОМ**  
غطاء ذكي

## WC BRUSH SET

Code	Height	Quality	Price \$
------	--------	---------	----------

KF68.304K.72	H.72 cm	S.S. 430	8	34,45
--------------	---------	----------	---	-------

**Туалет щетки держатель**  
مجموعة فرشاة مرحاض بقاعدة



**NEW!**



## PAINTED WC BRUSHES

Code	Diameter	Color	Height	Quality	Price \$
KF90.101B.36	Ø 8	WHITE	H.36 cm	S.S. 430	20 6,07
KF91.102S.36	Ø 8	BLACK	H.36 cm	S.S. 430	20 6,07
KF92.103P.36	Ø 8	PINK	H.36 cm	S.S. 430	20 6,07
KF93.104K.36	Ø 8	RED	H.36 cm	S.S. 430	20 6,07
KF94.105M.36	Ø 8	PURPLE	H.36 cm	S.S. 430	20 6,07

**NEW!**



## HYGIENIC BRUSHES

Code	Diameter	Height	Quality	Price \$
KF61.304K.36	Ø 8	H.36 cm	S.S. 304	20 5,50

\*Hygiene Brushes Are Not Included In The Price And Are Sold Separately

**NEW!**



## HYGIENIC BRUSHES

Code	Diameter	Height	Quality	Price \$
------	----------	--------	---------	----------

### ECO TYPE

KF62.304K.36	Ø 8,5	H.36 cm	S.S. 304	20 7,37
--------------	-------	---------	----------	---------

### LUXURY TYPE

KF63.304K.36		36x8x8 cm	S.S. 304	20 9,32
--------------	--	-----------	----------	---------



# DISABLED SERIES

# DISABLED SERIES

# h10

Ø 19



SS 304



## GRAB BAR

Code	Size	Quality		Price \$
4819.1920P304.00	8,5x20 cm	S.S. 304	10	8,70
4819.1930P304.00	8,5x30 cm	S.S. 304	10	9,55
4819.1940P304.00	8,5x40 cm	S.S. 304	10	10,38
4819.1950P304.00	8,5x50 cm	S.S. 304	10	11,23
4819.1960P304.00	8,5x60 cm	S.S. 304	10	12,07

Держатель для инвалидов диаметр 19  
قضبان للتمسك Ø 19

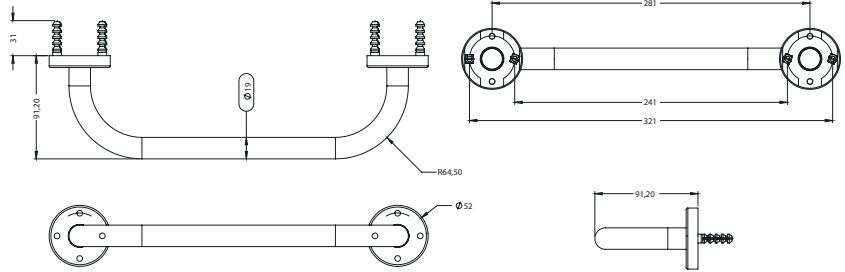

## GRAB BAR

Ø 25



SS 304



Code	Size	Quality		Price \$
4819.2520P304.00	8x20 cm	S.S. 304	10	9,83
4819.2530P304.00	8x30 cm	S.S. 304	10	11,00
4819.2540P304.00	8x40 cm	S.S. 304	10	12,17
4819.2550P304.00	8x50 cm	S.S. 304	10	13,32
4819.2560P304.00	8x60 cm	S.S. 304	10	14,48

ПОРУЧЕНЬ ДИАМЕТР 25  
قضبان للتمسك Ø 25

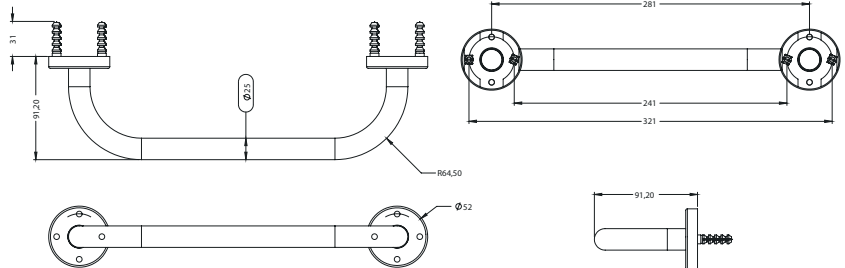

## GRAB BAR

Ø 32



SS 304



Code	Size	Quality		Price \$
4819.3230P304.00	10,5x30 cm	S.S. 304	10	14,73
4819.3240P304.00	10,5x40 cm	S.S. 304	10	16,17
4819.3250P304.00	10,5x50 cm	S.S. 304	10	17,60
4819.3260P304.00	10,5x60 cm	S.S. 304	10	19,05

ПОРУЧЕНЬ ДИАМЕТР 32  
قضبان للتمسك Ø 32

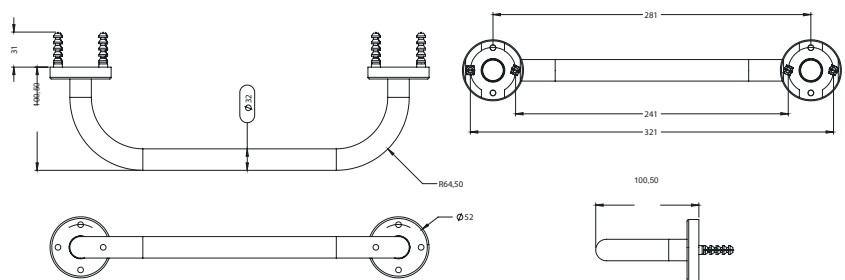

## ANGLE GRAB BAR

Code	Size	Quality		Price \$
4826.1950P304.00	Ø 19 20x50x10 cm	S.S. 304	10	11,23
4826.2564P304.00	Ø 25 22x64x10 cm	S.S. 304	10	13,32
4826.3264P304.00	Ø 32 20x50x10 cm	S.S. 304	10	20,33

### ДЕРЖАТЕЛЬ ДЛЯ ИНВАЛИДОВ С УГЛАМИ

قضبان للتمسك بزواوية



SS 304



## ANGLE GRAB BAR WITH SPONGE HOLDER

Code	Size	Quality		Price \$
4827.1950P304.00	Ø 19 19x20x50x10 cm	S.S. 304	10	16,90
4827.2550P304.00	Ø 25 25x18x50x10 cm	S.S. 304	10	18,85

### ДЕРЖАТЕЛЬ ДЛЯ ИНВАЛИДОВ С МЫЛЬНИЦЕЙ

قضبان للتمسك بزواوية وباسفنج



SS 304



## BASIN GRAB BAR

Code	Size	Quality		Price \$
4838.7080P304.00	Ø 32 76x74x80 cm	S.S. 304	1	95,17

### ПОРУЧЕНЬ В ТУАЛТЕ

قضيب تمسك للمغسلة



SS 304



# DISABLED SERIES

# h10

## FOOTED GRAB BAR

Code	Length	Quality		Price \$
------	--------	---------	---	----------

4828.7611P304.00	Ø 32 75x73 cm	SS. 304	5	76,98
------------------	---------------	---------	---	-------

**НА ПОДСТАВКЕ**  
بقدم



SS  
304



## STANDARD GRAB BAR

Code	Length	Quality		Price \$
------	--------	---------	---	----------

4832.2311P304.00	Ø 32 73x23x11 cm	SS. 304	5	33,52
------------------	------------------	---------	---	-------

**СТАНДАРТНЫЙ**  
قياسي



SS  
304



## SWIVEL GRAB BAR WITH TOILET PAPER HOLDER

Code	Length	Quality		Price \$
------	--------	---------	---	----------

4833.2311P304.00	Ø 32 73x23x11 cm	SS. 304	5	40,45
------------------	------------------	---------	---	-------

**ОТКИДНОЙ ПОРУЧЕНЬ С ДЕРЖАТЕЛЕМ ДЛЯ БУМАГИ**  
مع مفصل وحامل ورق مرحاض



SS  
304



## SWIVEL GRAB BAR WITH TOILET PAPER HOLDER

Code	Length	Quality		Price \$
------	--------	---------	---	----------

4835.2311P304.00	Ø 32 73x23x11 cm	SS. 304	5	41,83
------------------	------------------	---------	---	-------



SS  
304





# DISABLED SERIES

# h10

## FLOOR TO WALL

Code	Length	Quality		Price \$
------	--------	---------	---	----------

4834.7500P304.00	Ø 32 75x75 cm	SS. 304	5	24,95
------------------	---------------	---------	---	-------

**С ПОЛА ДО СТЕНЫ**  
من الأرض للجدار



SS  
304



## FLOOR TO WALL CANE LEG

Code	Length	Quality		Price \$
------	--------	---------	---	----------

4836.7500P304.00	Ø 32 75x75x30 cm	SS. 304	5	33,75
------------------	------------------	---------	---	-------

**С ПОЛА ДО СТЕНЫ С ДОПОЛНИТЕЛЬНОЙ НОЖКОЙ**  
من الأرض للجدار قضيب للمشي



SS  
304



## ANGLE GRAB BAR

Code	Length	Quality		Price \$
------	--------	---------	---	----------

4831.4012P304.00	Ø 32 80x40x12 cm	SS. 304	1	30,83
------------------	------------------	---------	---	-------

**УГЛОВОЙ ПОРУЧЕНЬ С УГЛАМИ**  
قضبان تمسك بزواوية للرايا



SS  
304



## L TYPE GRAB BAR

Code	Length	Quality		Price \$
------	--------	---------	---	----------

4837.4012P304.00	Ø 32 80x40x12cm	SS. 304	1	30,83
------------------	-----------------	---------	---	-------

**ПОРУЧЕНЬ ТИПА L**  
قضيب تمسك نوع L



SS  
304



# DISABLED SERIES

# h10

## PLASTIC DISABLED SHOWER SEAT

Code	Length	Quality		Price \$
------	--------	---------	---	----------

4820.4043S.304.00	Ø 19 43x40x39.5 cm	SS. 304	5	61,30
-------------------	--------------------	---------	---	-------

**СИДЕНИЕ В ВАННУЮ ДЛЯ ИНВАЛИДОВ ПЛАСТИКОВОЕ**  
مقعد دوش بلاستيكي لذوي الاحتياجات



SS  
304



## WOODEN DISABLED SHOWER SEAT

Code	Length	Quality		Price \$
------	--------	---------	---	----------

4820.4041S.304.00	Ø 19 46x43.5x39 cm	SS. 304	5	64,48
-------------------	--------------------	---------	---	-------

**СИДЕНИЕ В ВАННУЮ ДЛЯ ИНВАЛИДОВ ДЕРЕВЯННОЕ**  
مقعد دوش خشبي لذوي الاحتياجات الخاصة



SS  
304



## DISABLED MIRROR

Code	Length	Quality		Price \$
------	--------	---------	---	----------

4821.5070S.304.00	50x70 cm	SS. 304	5	42,43
-------------------	----------	---------	---	-------

**ЗЕРКАЛО ДЛЯ ИНВАЛИДОВ**  
مرآة لذوي الاحتياجات الخاصة



SS  
304



## DISABLED MIRROR WITH HANDLE

Code	Length	Quality		Price \$
------	--------	---------	---	----------

4840.5070S.304.00	50x70 cm	SS. 304	5	45,03
-------------------	----------	---------	---	-------

**ЗЕРКАЛО С РУЧКОЙ ДЛЯ ИНВАЛИДОВ**  
مرآة لذوي الاحتياجات الخاصة بمقبض



SS  
304





# SHOWER CHANNEL

# CLASSIC SERIES

# h10

## LINE



\* Shower drain / Ø 50 side outlet / Plastic body / Stainless grid / Odor blocking by water  
 \* Душ канал / Ø 50 боковой выход / пластиковое тело / Нержавеющая щетка / Гидрозатвор  
 قنّاة دش / مصرف جانبي / بلاستيكي / مقاوم للصدأ / حابيس رائحة مياہ



\* Shower drain / Ø 50 vertical outlet / Plastic body / Stainless grid / Odor blocking by water  
 \* Душ канал / Ø 50 Нижний выход / пластиковое тело / Нержавеющая щетка / Гидрозатвор  
 قنّاة دش / بمصرف سفلي / بھیکل بلاستيكي / شبكة مقاوم للصدأ / حابيس رائحة مياہ

Code Outlet Length Price \$

40I2.0Y050K.020.1	Ø 50	20 cm	12	9,60
40I2.0Y050K.033.1	Ø 50	33 cm	12	11,82
40I2.0Y050K.040.1	Ø 50	40 cm	12	12,80
40I2.0Y050K.050.1	Ø 50	50 cm	12	14,23
40I2.0Y050K.060.1	Ø 50	60 cm	12	16,05
40I2.0Y050K.080.1	Ø 50	80 cm	12	18,83

40I2.0A050K.020.1	Ø 50	20 cm	12	9,60
40I2.0A050K.033.1	Ø 50	33 cm	12	11,82
40I2.0A050K.040.1	Ø 50	40 cm	12	12,80
40I2.0A050K.050.1	Ø 50	50 cm	12	14,23
40I2.0A050K.060.1	Ø 50	60 cm	12	16,05
40I2.0A050K.080.1	Ø 50	80 cm	12	18,83

## LINE GOLD



\* Shower drain / Ø 50 side outlet / Plastic body / Stainless grid / Odor blocking by water  
 \* Душ канал / Ø 50 боковой выход / пластиковое тело / Нержавеющая щетка / Гидрозатвор  
 قنّاة دش / مصرف جانبي / بلاستيكي / مقاوم للصدأ / حابيس رائحة مياہ



\* Shower drain / Ø 50 vertical outlet / Plastic body / Stainless grid / Odor blocking by water  
 \* Душ канал / Ø 50 Нижний выход / пластиковое тело / Нержавеющая щетка / Гидрозатвор  
 قنّاة دش / بمصرف سفلي / بھیکل بلاستيكي / شبكة مقاوم للصدأ / حابيس رائحة مياہ

Code Outlet Length Price \$

40I2.0Y050G.020.1	Ø 50	20 cm	12	13,60
40I2.0Y050G.033.1	Ø 50	33 cm	12	17,47
40I2.0Y050G.040.1	Ø 50	40 cm	12	19,30
40I2.0Y050G.050.1	Ø 50	50 cm	12	21,95
40I2.0Y050G.060.1	Ø 50	60 cm	12	25,07
40I2.0Y050G.080.1	Ø 50	80 cm	12	30,08

40I2.0A050G.020.1	Ø 50	20 cm	12	13,60
40I2.0A050G.033.1	Ø 50	33 cm	12	17,47
40I2.0A050G.040.1	Ø 50	40 cm	12	19,30
40I2.0A050G.050.1	Ø 50	50 cm	12	21,95
40I2.0A050G.060.1	Ø 50	60 cm	12	25,07
40I2.0A050G.080.1	Ø 50	80 cm	12	30,08

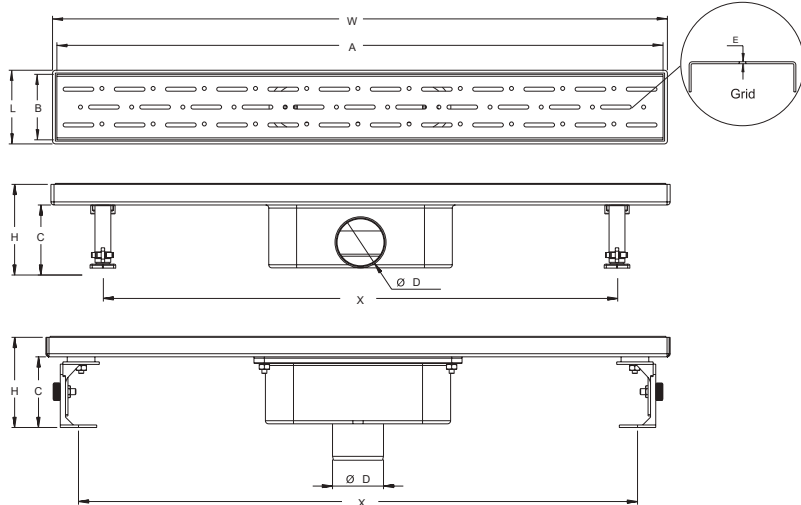

DN 50 side and vertical outlet - compatible with PVC pipe connections, blocking odor by water (36mm). The flow rate is 32 liters/min. Resistant against external chemical effects, operating temperature is between - 30°C and +75°C. The grid is made of 304 grade stainless steel.

With its 304 grade stainless steel grid, it has a quality and stylish-looking. It can be easily applied at floor. With its odor blocking by water support, it prevents the bad smell coming from the installation. With its adjustable height legs, it can be adjusted depending on the screed concrete. High resistance against the organic and inorganic chemicals, resistant against most acidic and vertically aqueous oxidation.

Common use of bathroom shower, hospital and hotel shower areas, locker-room shower areas etc.

Grid patterns can be chosen in gold, bronze or other optional colors in accordance with your desire.

It is not recommended to use high-density cleaners for a long-time.

	W	L	H	H1	ØD	A	B	C	X	E
	205	72	88	115	49.5	196	64	68	-	1
33 cm	330	72	88	115	49.5	322	64	68	285	1
	400	72	88	115	49.5	392	64	68	335	1
50 cm	500	72	88	115	49.5	492	64	68	435	1
	600	72	88	115	49.5	592	64	68	556	1
80 cm	785	72	88	115	49.5	778	64	68	737	1

Table measure "mm"



# CLASSIC SERIES

h10

## LEGAL



\* Shower drain / Ø 50 side outlet / Stainless body / Stainless steel grid and frame / Odor blocking by water  
 \* Душ канал / Ø 50 боковой выход / Корпус Из Нержавеющей / Нержавеющая щетка / Гидрозатвор  
 قناة دش / مصرف جانبي / هيكل بلاستيكي / إطار من شبكة مقاومة للصدأ / حابيس رائحة المياه



\* Shower drain / Ø 50 vertical outlet / Stainless body / Stainless steel grid and frame / Odor blocking by water  
 \* Душ канал / Ø 50 Нижний выход / Корпус Из Нержавеющей / Нержавеющая щетка / Гидрозатвор  
 قناة دش / بمصرف سفلي / هيكل بلاستيكي / إطار من شبكة مقاومة للصدأ / حابيس رائحة المياه

Code Outlet Length Price \$

Code	Outlet	Length	Price \$
40I3.0Y050K.020.1	Ø 50	20 cm	19,13
40I3.0Y050K.033.1	Ø 50	33 cm	23,32
40I3.0Y050K.040.1	Ø 50	40 cm	26,10
40I3.0Y050K.050.1	Ø 50	50 cm	30,47
40I3.0Y050K.060.1	Ø 50	60 cm	34,30
40I3.0Y050K.080.1	Ø 50	80 cm	41,38

Code	Outlet	Length	Price \$
40I3.0A050K.020.1	Ø 50	20 cm	19,13
40I3.0A050K.033.1	Ø 50	33 cm	23,32
40I3.0A050K.040.1	Ø 50	40 cm	26,10
40I3.0A050K.050.1	Ø 50	50 cm	30,47
40I3.0A050K.060.1	Ø 50	60 cm	34,30
40I3.0A050K.080.1	Ø 50	80 cm	41,38

## LEGAL GOLD



\* Shower drain / Ø 50 side outlet / Stainless body / Stainless steel grid and frame / Odor blocking by water  
 \* Душ канал / Ø 50 боковой выход / Корпус Из Нержавеющей / Нержавеющая щетка / Гидрозатвор  
 قناة دش / مصرف جانبي / هيكل بلاستيكي / إطار من شبكة مقاومة للصدأ / حابيس رائحة المياه



\* Shower drain / Ø 50 vertical outlet / Stainless body / Stainless steel grid and frame / Odor blocking by water  
 \* Душ канал / Ø 50 Нижний выход / Корпус Из Нержавеющей / Нержавеющая щетка / Гидрозатвор  
 قناة دش / بمصرف سفلي / هيكل بلاستيكي / إطار من شبكة مقاومة للصدأ / حابيس رائحة المياه

Code Outlet Length Price \$

Code	Outlet	Length	Price \$
40I3.0Y050G.020.1	Ø 50	20 cm	24,00
40I3.0Y050G.033.1	Ø 50	33 cm	32,52
40I3.0Y050G.040.1	Ø 50	40 cm	37,00
40I3.0Y050G.050.1	Ø 50	50 cm	43,82
40I3.0Y050G.060.1	Ø 50	60 cm	50,05
40I3.0Y050G.080.1	Ø 50	80 cm	61,60

Code	Outlet	Length	Price \$
40I3.0A050G.020.1	Ø 50	20 cm	24,00
40I3.0A050G.033.1	Ø 50	33 cm	32,52
40I3.0A050G.040.1	Ø 50	40 cm	37,00
40I3.0A050G.050.1	Ø 50	50 cm	43,82
40I3.0A050G.060.1	Ø 50	60 cm	50,05
40I3.0A050G.080.1	Ø 50	80 cm	61,60



## LEGAL



Code	Outlet	Length		Price \$
------	--------	--------	--	----------

4013.0Y050R020.1	Ø 50	20 cm	12	24,00
4013.0Y050R033.1	Ø 50	33 cm	12	32,52
4013.0Y050R040.1	Ø 50	40 cm	12	37,00
4013.0Y050R050.1	Ø 50	50 cm	12	43,82
4013.0Y050R060.1	Ø 50	60 cm	12	50,05
4013.0Y050R080.1	Ø 50	80 cm	12	61,60

## LEGAL 360°



Code	Outlet	Length		Price \$
------	--------	--------	--	----------

4013.00360K.020.1	Ø 50	20 cm	12	21,18
4013.00360K.033.1	Ø 50	33 cm	12	24,67
4013.00360K.040.1	Ø 50	40 cm	12	26,75
4013.00360K.050.1	Ø 50	50 cm	12	30,32
4013.00360K.060.1	Ø 50	60 cm	12	33,57
4013.00360K.080.1	Ø 50	80 cm	12	40,90

\* Shower drain / Ø 50 side outlet / Stainless body / Stainless steel grid and frame / Odor blocking by water  
 \* Душ канал / Ø 50 боковой выход / Корпус Из Нержавеющей / Нержавеющая щетка / Гидрозатвор

قناة دش / مصرف جانبي / هيكل بلاستيكي / إطار من شبكة مقاومة للصدأ / حابس رائحة المياه

## LEGAL GOLD 360°

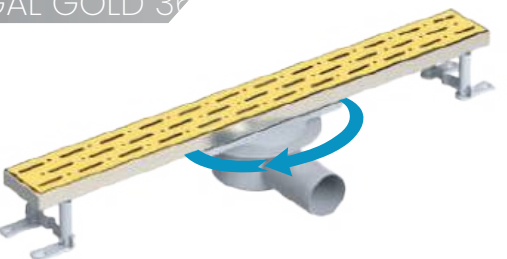

Code	Outlet	Length		Price \$
------	--------	--------	--	----------

4013.00360G.020.1	Ø 50	20 cm	12	27,47
4013.00360G.033.1	Ø 50	33 cm	12	33,97
4013.00360G.040.1	Ø 50	40 cm	12	37,70
4013.00360G.050.1	Ø 50	50 cm	12	43,65
4013.00360G.060.1	Ø 50	60 cm	12	48,38
4013.00360G.080.1	Ø 50	80 cm	12	61,08

\* Shower drain / Ø 50 side outlet / Stainless body / Stainless steel grid and frame / Odor blocking by water  
 \* Душ канал / Ø 50 боковой выход / Корпус Из Нержавеющей / Нержавеющая щетка / Гидрозатвор

قناة دش / مصرف جانبي / هيكل بلاستيكي / إطار من شبكة مقاومة للصدأ / حابس رائحة المياه

# CLASSIC SERIES

h10

## LEGAL Y360°

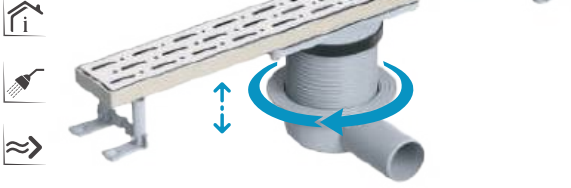

\* Shower drain / Ø 50 side outlet / Stainless body / Stainless steel grid and frame / Odor blocking by water  
 \* Душ канал / Ø 50 боковой выход / Корпус Из Нержавеющей / Нержавеющая щетка / Гидрозатвор  
 قناة دش / مصرف جانبي / هيكل بلاستيكي / إطار من شبكة مقاومة للصدأ / حابس رائحة المياه

Code	Outlet	Length		Price \$
40I3.0Y360K.020.1	Ø 50	20 cm	12	25,38
40I3.0Y360K.033.1	Ø 50	33 cm	12	28,45
40I3.0Y360K.040.1	Ø 50	40 cm	12	30,73
40I3.0Y360K.050.1	Ø 50	50 cm	12	34,10
40I3.0Y360K.060.1	Ø 50	60 cm	12	37,43
40I3.0Y360K.080.1	Ø 50	80 cm	12	44,18

## LEGAL GOLD Y360°

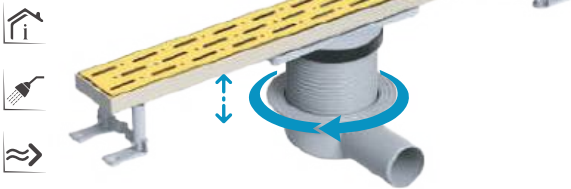

\* Shower drain / Ø 50 side outlet / Stainless body / Stainless steel grid and frame / Odor blocking by water  
 \* Душ канал / Ø 50 боковой выход / Корпус Из Нержавеющей / Нержавеющая щетка / Гидрозатвор  
 قناة دش / مصرف جانبي / هيكل بلاستيكي / إطار من شبكة مقاومة للصدأ / حابس رائحة المياه

Code	Outlet	Length		Price \$
40I3.0Y360G.020.1	Ø 50	20 cm	12	28,83
40I3.0Y360G.033.1	Ø 50	33 cm	12	33,18
40I3.0Y360G.040.1	Ø 50	40 cm	12	36,22
40I3.0Y360G.050.1	Ø 50	50 cm	12	40,63
40I3.0Y360G.060.1	Ø 50	60 cm	12	45,03
40I3.0Y360G.080.1	Ø 50	80 cm	12	53,80

## LEGAL

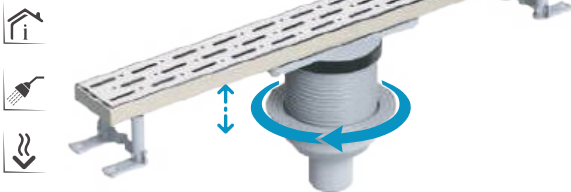

\* Shower drain / Ø 50 vertical outlet / Stainless body / Stainless steel grid and frame / Odor blocking by water  
 \* Душ канал / Ø 50 боковой выход / Корпус Из Нержавеющей / Нержавеющая щетка / С регулировкой высоты / Гидрозатвор  
 قناة دش / بمصرف سفلي / هيكل بلاستيكي / إطار من شبكة مقاومة للصدأ / حابس رائحة المياه

Code	Outlet	Length		Price \$
40I3.0A360K.020.1	Ø 50	20 cm	12	25,38
40I3.0A360K.033.1	Ø 50	33 cm	12	28,45
40I3.0A360K.040.1	Ø 50	40 cm	12	30,73
40I3.0A360K.050.1	Ø 50	50 cm	12	34,10
40I3.0A360K.060.1	Ø 50	60 cm	12	37,43
40I3.0A360K.080.1	Ø 50	80 cm	12	44,18

## LEGAL GOLD

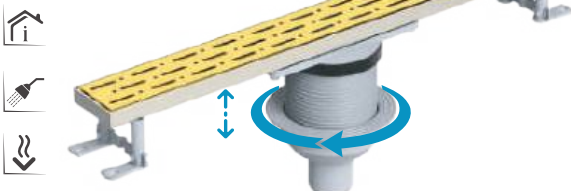

\* Shower drain / Ø 50 vertical outlet / Stainless body / Stainless steel grid and frame / Odor blocking by water  
 \* Душ канал / Ø 50 боковой выход / Корпус Из Нержавеющей / Нержавеющая щетка / С регулировкой высоты / Гидрозатвор  
 قناة دش / بمصرف سفلي / هيكل بلاستيكي / إطار من شبكة مقاومة للصدأ / حابس رائحة المياه

Code	Outlet	Length		Price \$
40I3.0A360G.020.1	Ø 50	20 cm	12	25,38
40I3.0A360G.033.1	Ø 50	33 cm	12	28,45
40I3.0A360G.040.1	Ø 50	40 cm	12	30,73
40I3.0A360G.050.1	Ø 50	50 cm	12	34,10
40I3.0A360G.060.1	Ø 50	60 cm	12	37,43
40I3.0A360G.080.1	Ø 50	80 cm	12	44,18



# CLASSIC SERIES

h10

## SCALA



\* Shower drain / Ø 50 side outlet / Stainless steel Compatible with ceramic frame / Odor blocking by water  
 \* Душ канал / Ø 50 боковой выход / Корпус Из Нержавеющей Керамика совместимая / Запах сочных держател  
 قناة دش / مصرف جانبي / هيكل مقاوم للصدأ متوافق مع السيراميك / حابيس رائحة المياه



\* Shower drain / Ø 50 vertical outlet / Stainless steel Compatible with ceramic frame / Odor blocking by water  
 \* Душ канал / Ø 50 Нижний выход / Корпус Из Нержавеющей Керамика совместимая / Гидрозатвор  
 قناة دش / بمصرف سفلي / هيكل مقاوم للصدأ متوافق مع السيراميك / حابيس رائحة المياه



\* Shower drain / Ø 50 vertical outlet / Stainless steel Compatible with ceramic frame / Odor blocking by water  
 \* Душ канал / Ø 50 Нижний выход / Корпус Из Нержавеющей Керамика совместимая / Гидрозатвор  
 قناة دش / بمصرف سفلي / هيكل مقاوم للصدأ متوافق مع السيراميك / حابيس رائحة المياه

## SCALA 360°



\* Shower drain / Ø 50 side outlet / Stainless steel Compatible with ceramic frame / Odor blocking by water  
 \* Душ канал / Ø 50 боковой выход / Корпус Из Нержавеющей Керамика совместимая / Запах сочных держател  
 قناة دش / مصرف جانبي / هيكل مقاوم للصدأ متوافق مع السيراميك / حابيس رائحة المياه

Code	Outlet	Length		Price \$
------	--------	--------	--	----------

40I4.0Y050K.020.1	Ø 50	20 cm	12	19,73
40I4.0Y050K.033.1	Ø 50	33 cm	12	26,18
40I4.0Y050K.040.1	Ø 50	40 cm	12	26,57
40I4.0Y050K.050.1	Ø 50	50 cm	12	30,53
40I4.0Y050K.060.1	Ø 50	60 cm	12	35,90
40I4.0Y050K.080.1	Ø 50	80 cm	12	43,10



40I4.0A050K.020.1	Ø 50	20 cm	12	19,73
40I4.0A050K.033.1	Ø 50	33 cm	12	26,18
40I4.0A050K.040.1	Ø 50	40 cm	12	26,57
40I4.0A050K.050.1	Ø 50	50 cm	12	30,53
40I4.0A050K.060.1	Ø 50	60 cm	12	35,90
40I4.0A050K.080.1	Ø 50	80 cm	12	43,10

40I4.0A050R020.1	Ø 50	20 cm	12	19,73
40I4.0A050R033.1	Ø 50	33 cm	12	26,18
40I4.0A050R040.1	Ø 50	40 cm	12	26,57
40I4.0A050R050.1	Ø 50	50 cm	12	30,53
40I4.0A050R060.1	Ø 50	60 cm	12	35,90
40I4.0A050R080.1	Ø 50	80 cm	12	43,10

Code	Outlet	Length		Price \$
------	--------	--------	--	----------

40I4.00360K.020.1	Ø 50	20 cm	12	21,07
40I4.00360K.033.1	Ø 50	33 cm	12	27,32
40I4.00360K.040.1	Ø 50	40 cm	12	29,70
40I4.00360K.050.1	Ø 50	50 cm	12	31,67
40I4.00360K.060.1	Ø 50	60 cm	12	37,25
40I4.00360K.080.1	Ø 50	80 cm	12	44,25



40I4.0Y360K.020.1	Ø 50	20 cm	12	25,17
40I4.0Y360K.033.1	Ø 50	33 cm	12	31,32
40I4.0Y360K.040.1	Ø 50	40 cm	12	35,57
40I4.0Y360K.050.1	Ø 50	50 cm	12	36,47
40I4.0Y360K.060.1	Ø 50	60 cm	12	41,35
40I4.0Y360K.080.1	Ø 50	80 cm	12	48,23





# STYLE SERIES

DN 50 side and vertical outlet - compatible with PVC pipe connections, blocking odor by water (36mm). The flow rate is 32 liters/min. Resistant against external chemical effects, operating temperature is between - 30°C and +75°C. The grid is made of 304 grade stainless steel.

With its 304 grade stainless steel grid, it has a quality and stylish-looking. It can be easily applied at floor. With its odor blocking by water support, it prevents the bad smell coming from the installation. With its adjustable height legs, it can be adjusted depending on the screed concrete. High resistance against the organic and inorganic chemicals, resistant against most acidic and vertically aqueous oxidation.

Common use of bathroom shower, hospital and hotel shower areas, locker-room shower areas etc.

Grid patterns can be chosen in gold, bronze or other optional colors in accordance with your desire.

It is not recommended to use high-density cleaners for a long-time.

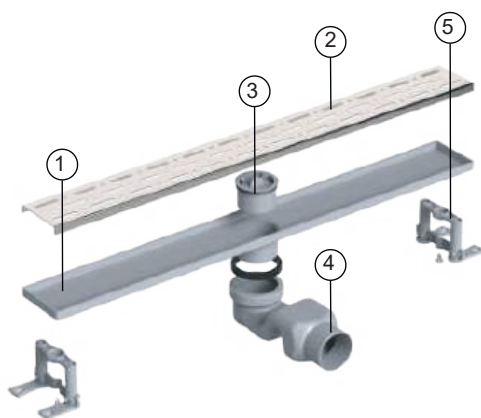

PART NO	PART DESCRIPTION	MATERIAL	PCS
	Plastic Body	ABS	1
4083.2	Stainless grid	AISI 304	1
	Odor blocking	PP	1
4083.4	S Siphon	PP	1
	Height adjustable legs	PP	2

# STYLE SERIES

# h10

## SIMPLE LINE



\* Shower drain / Ø 50 vertical outlet / Plastic body / Stainless grid / Odor blocking by water  
 \* Душ канал / Ø 50 Нижний выход / пластиковое тело / Нержавеющая щетка / Гидрозатвор

Code	Outlet	Length		Price \$	
4080.0A050K.033.1	Ø 50	33 cm	12	7,35	
4080.0A050K.040.1	Ø 50	40 cm	12	8,78	
4080.0A050K.050.1	Ø 50	50 cm	12	10,37	
4080.0A050K.060.1	Ø 50	60 cm	12	12,08	
4080.0A050K.080.1	Ø 50	80 cm	12	14,58	

## LINE

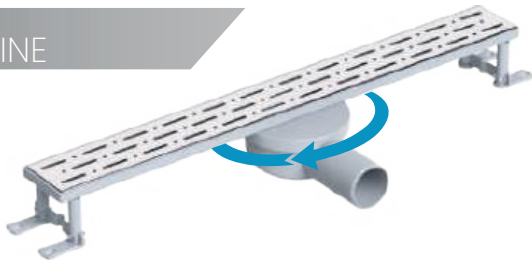

\* Shower drain / Ø 50 horizontal outlet / Plastic body / Stainless grid / Odor blocking by water  
 \* Душ канал / Ø 50 Боковой выход / пластиковое тело / Нержавеющая щетка / Гидрозатвор

Code	Outlet	Length		Price \$	
4081.0Y050K.033.1	Ø 50	33 cm	12	11,30	
4081.0Y050K.040.1	Ø 50	40 cm	12	12,65	
4081.0Y050K.050.1	Ø 50	50 cm	12	14,17	
4081.0Y050K.060.1	Ø 50	60 cm	12	15,87	
4081.0Y050K.080.1	Ø 50	80 cm	12	18,53	



\* Shower drain / Ø 50 vertical outlet / Plastic body / Stainless grid / Odor blocking by water  
 \* Душ канал / Ø 50 Нижний выход / пластиковое тело / Нержавеющая щетка / Гидрозатвор

4082.0A050K.033.1	Ø 50	33 cm	12	11,30	
4082.0A050K.040.1	Ø 50	40 cm	12	12,65	
4082.0A050K.050.1	Ø 50	50 cm	12	14,17	
4082.0A050K.060.1	Ø 50	60 cm	12	15,87	
4082.0A050K.080.1	Ø 50	80 cm	12	18,53	

## STYLE SIFONIK



\* Shower drain / Ø 50 horizontal outlet / Plastic body / Stainless grid / Odor blocking by water  
 \* Душ канал / Ø 50 Боковой выход / пластиковое тело / Нержавеющая щетка / Гидрозатвор

Code	Outlet	Length		Price \$	
4083.0Y050K.033.1	Ø 50	33 cm	12	9,73	
4083.0Y050K.040.1	Ø 50	40 cm	12	11,10	
4083.0Y050K.050.1	Ø 50	50 cm	12	12,62	
4083.0Y050K.060.1	Ø 50	60 cm	12	14,30	
4083.0Y050K.080.1	Ø 50	80 cm	12	16,98	

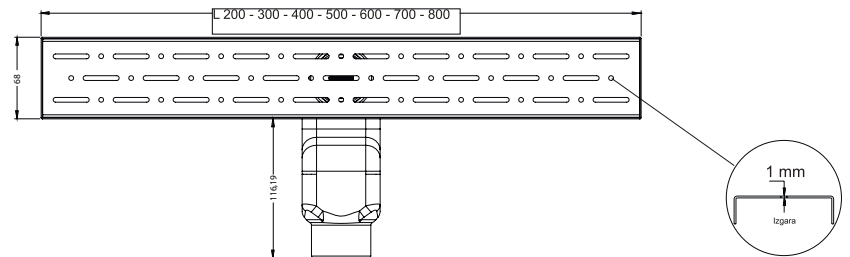
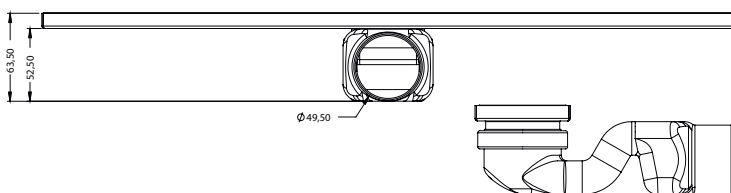

# STYLE SERIES

# h10

## SIMPLE LEGAL



\* Shower drain / Ø 50 vertical outlet / Stainless body / Stainless grid / Odor blocking by water  
 \* Душ канал / Ø 50 Нижний выход / Нержавеющее тело / Нержавеющая щетка / Гидрозатвор  
 بمصرف سفلي / هيكل و اطار مقاوم للصدأ / حابس رائحة مياه قناة دش 50

Code Outlet Length Price \$

Code	Outlet	Length	Icon	Price \$
4086.0A050K.020.I	Ø 50	20 cm	12	11,73
4086.0A050K.033.I	Ø 50	33 cm	12	14,72
4086.0A050K.040.I	Ø 50	40 cm	12	17,78
4086.0A050K.050.I	Ø 50	50 cm	12	20,73
4086.0A050K.060.I	Ø 50	60 cm	12	23,70
4086.0A050K.070.I	Ø 50	70 cm	12	26,53
4086.0A050K.080.I	Ø 50	80 cm	12	29,05

## LEGAL



\* Shower drain / Ø 50 horizontal outlet / Stainless body / Stainless grid / Odor blocking by water  
 \* Душ канал / Ø 50 Боковой выход / Нержавеющее тело / Нержавеющая щетка / Гидрозатвор  
 بمصرف جانبي / هيكل و اطار مقاوم للصدأ / حابس رائحة مياه قناة دش 50

Code Outlet Length Price \$

Code	Outlet	Length	Icon	Price \$
4087.0Y050K.020.I	Ø 50	20 cm	12	15,25
4087.0Y050K.033.I	Ø 50	33 cm	12	18,25
4087.0Y050K.040.I	Ø 50	40 cm	12	21,32
4087.0Y050K.050.I	Ø 50	50 cm	12	24,32
4087.0Y050K.060.I	Ø 50	60 cm	12	27,42
4087.0Y050K.070.I	Ø 50	70 cm	12	30,42
4087.0Y050K.080.I	Ø 50	80 cm	12	33,08

## LEGAL SIFONIK



\* Shower drain / Ø 50 horizontal outlet / Stainless body / Stainless grid / Odor blocking by water  
 \* Душ канал / Ø 50 Боковой выход / Нержавеющее тело / Нержавеющая щетка / Гидрозатвор  
 بمصرف جانبي / هيكل و اطار مقاوم للصدأ / حابس رائحة مياه قناة دش 50

Code Outlet Length Price \$

Code	Outlet	Length	Icon	Price \$
4084.0Y050K.020.I	Ø 50	20 cm	12	13,95
4084.0Y050K.030.I	Ø 50	33 cm	12	16,93
4084.0Y050K.040.I	Ø 50	40 cm	12	20,00
4084.0Y050K.050.I	Ø 50	50 cm	12	23,02
4084.0Y050K.060.I	Ø 50	60 cm	12	26,12
4084.0Y050K.070.I	Ø 50	70 cm	12	29,10
4084.0Y050K.080.I	Ø 50	80 cm	12	31,77

PART NO	PART DESCRIPTION	MATERIAL	PCS
	SS Body	AISI 304	1
4084.2	Stainless grid	AISI 304	1
	Odor blocking	PP	1
4084.4	S Siphon	PP	1

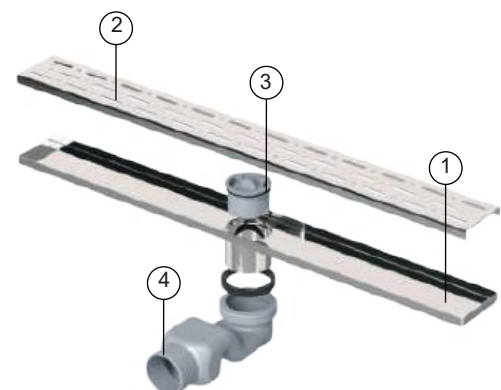

# STYLE SERIES

# h10

## LINE MESH



Code      Outlet      Length           Price \$

4092.FY050K.033.1	Ø 50	33 cm	12	13,60
4092.FY050K.040.1	Ø 50	40 cm	12	14,65
4092.FY050K.050.1	Ø 50	50 cm	12	16,45
4092.FY050K.060.1	Ø 50	60 cm	12	18,17
4092.FY050K.080.1	Ø 50	80 cm	12	20,85

\* Shower drain / Ø 50 vertical outlet / Plastic body / Stainless grid / Odor blocking by water  
 \* Душ канал / Ø 50 Нижний выход / пластичное тело / Нержавеющая щетка / Гидрозатвор

مصرف جانبي / جسم بلاستيكي / شبكة مقاوم للصدأ / حابس رائحة مياه

قناة دش / 50Ø

4093.FA050K.033.1	Ø 50	33 cm	12	13,60
4093.FA050K.040.1	Ø 50	40 cm	12	14,65
4093.FA050K.050.1	Ø 50	50 cm	12	16,45
4093.FA050K.060.1	Ø 50	60 cm	12	18,17
4093.FA050K.080.1	Ø 50	80 cm	12	20,85

\* Shower drain / Ø 50 horizontal outlet / Plastic body / Stainless grid / Odor blocking by water

\* Душ канал / Ø 50 Боковой выход / пластичное тело / Нержавеющая щетка / Гидрозатвор

بمصرف سفلي / جسم بلاستيكي / شبكة مقاوم للصدأ / حابس رائحة مياه

قناة دش / 50Ø

## LEGAL MESH



Code      Outlet      Length           Price \$

4094.FY050K.020.1	Ø 50	20 cm	12	18,37
4094.FY050K.033.1	Ø 50	33 cm	12	21,12
4094.FY050K.040.1	Ø 50	40 cm	12	24,13
4094.FY050K.050.1	Ø 50	50 cm	12	27,27
4094.FY050K.060.1	Ø 50	60 cm	12	30,23
4094.FY050K.070.1	Ø 50	70 cm	12	33,23
4094.FY050K.080.1	Ø 50	80 cm	12	35,90

\* Shower drain / Ø 50 vertical outlet / Stainless body / Stainless grid / Odor blocking by water

\* Душ канал / Ø 50 Нижний выход / Нержавеющее тело / Нержавеющая щетка / Гидрозатвор

مصرف جانبي / جسم بلاستيكي / شبكة مقاوم للصدأ / حابس رائحة مياه

قناة دش / 50Ø

4094.FA050K.020.1	Ø 50	20 cm	12	18,37
4094.FA050K.033.1	Ø 50	33 cm	12	21,12
4094.FA050K.040.1	Ø 50	40 cm	12	24,13
4094.FA050K.050.1	Ø 50	50 cm	12	27,27
4094.FA050K.060.1	Ø 50	60 cm	12	30,23
4094.FA050K.070.1	Ø 50	70 cm	12	33,23
4094.FA050K.080.1	Ø 50	80 cm	12	35,90

\* Shower drain / Ø 50 horizontal outlet / Stainless body / Stainless grid / Odor blocking by water

\* Душ канал / Ø 50 Боковой выход / Нержавеющее тело / Нержавеющая щетка / Гидрозатвор

بمصرف سفلي / جسم بلاستيكي / شبكة مقاوم للصدأ / حابس رائحة مياه

قناة دش / 50Ø

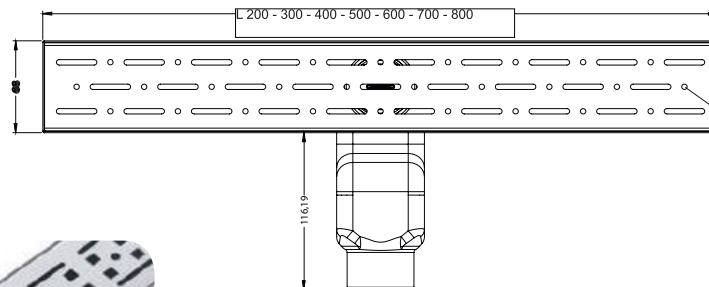
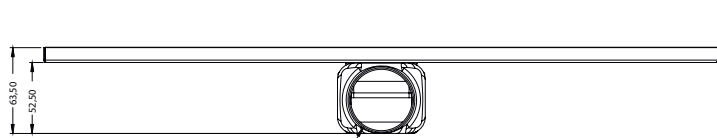

RAIN

SQUARE

FISH

BAHN

MARYLAND

# STYLE SERIES

# h10

## VEGA



\* Shower drain / Ø 50 vertical outlet / Stainless body / Stainless grid / Odor blocking by water  
 \* Душ канал / Ø 50 Нижний выход / Нержавеющее тело / Нержавеющая щетка / Гидрозатвор  
 بمصرف سفلي / هيكل و اطار مقاوم للصدأ / حابس رائحة مياه قناة دش / 50Ø

Code

Outlet

Length



Price \$

4074.0A050K.040.1	Ø 50	40 cm	12	16,98
4074.0A050K.050.1	Ø 50	50 cm	12	19,85
4074.0A050K.060.1	Ø 50	60 cm	12	21,50

## VEGA

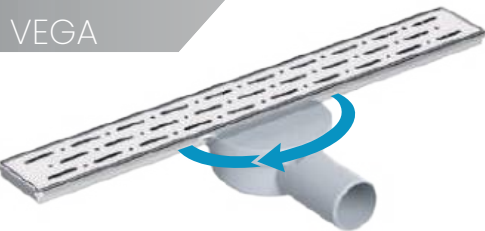

\* Shower drain / Ø 50 horizontal outlet / Stainless body / Stainless grid / Odor blocking by water  
 \* Душ канал / Ø 50 Боковой выход / Нержавеющее тело / Нержавеющая щетка / Гидрозатвор  
 بمصرف جانبي / هيكل و اطار مقاوم للصدأ / حابس رائحة مياه قناة دش / 50Ø

Code

Outlet

Length



Price \$

4075.0Y050K.040.1	Ø 50	40 cm	12	21,92
4075.0Y050K.050.1	Ø 50	50 cm	12	23,68
4075.0Y050K.060.1	Ø 50	60 cm	12	25,85



\* Shower drain / Ø 50 vertical outlet / Stainless body / Stainless grid / Odor blocking by water  
 \* Душ канал / Ø 50 Нижний выход / Нержавеющее тело / Нержавеющая щетка / Гидрозатвор  
 بمصرف سفلي / هيكل و اطار مقاوم للصدأ / حابس رائحة مياه قناة دش / 50Ø

Code

Outlet

Length



Price \$

4075.0A050K.040.1	Ø 50	40 cm	12	21,92
4075.0A050K.050.1	Ø 50	50 cm	12	23,68
4075.0A050K.060.1	Ø 50	60 cm	12	25,85

## VEGA SIFONIK



\* Shower drain / Ø 50 horizontal outlet / Stainless body / Stainless grid / Odor blocking by water  
 \* Душ канал / Ø 50 Боковой выход / Нержавеющее тело / Нержавеющая щетка / Гидрозатвор  
 بمصرف جانبي / هيكل و اطار مقاوم للصدأ / حابس رائحة مياه قناة دش / 50Ø

Code

Outlet

Length



Price \$

4076.0Y050K.040.1	Ø 50	40 cm	12	17,88
4076.0Y050K.050.1	Ø 50	50 cm	12	20,77
4076.0Y050K.060.1	Ø 50	60 cm	12	22,80



RAIN



SQUARE



FISH



BAHN



MARYLAND



SOLID

# STYLE SERIES

# h10

## VEGA LUX



Code Outlet Length Price \$

4077.0A050K.040.1	Ø 50	40 cm	12	20,85
4077.0A050K.050.1	Ø 50	50 cm	12	23,55
4077.0A050K.060.1	Ø 50	60 cm	12	26,62

\* Shower drain / Ø 50 vertical outlet / Stainless body / Stainless grid / Odor blocking by water  
 \* Душ канал / Ø 50 Нижний выход / Нержавеющее тело / Нержавеющая щетка / Гидрозатвор  
 بمصرف سفلي / هيكل و اطار مقاوم للصدأ / حابس رائحة مياه قناة دش / 50

## VEGA LUX

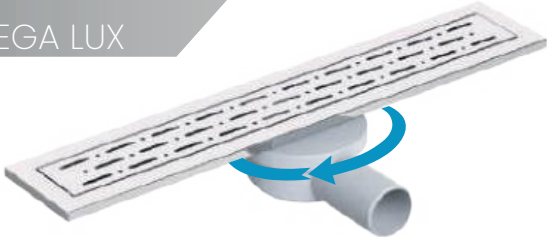

Code Outlet Length Price \$

4078.0Y050K.040.1	Ø 50	40 cm	12	24,33
4078.0Y050K.050.1	Ø 50	50 cm	12	27,05
4078.0Y050K.060.1	Ø 50	60 cm	12	30,10

\* Shower drain / Ø 50 horizontal outlet / Stainless body / Stainless grid / Odor blocking by water  
 \* Душ канал / Ø 50 Боковой выход / Нержавеющее тело / Нержавеющая щетка / Гидрозатвор  
 مصرف جانبي / هيكل و اطار مقاوم للصدأ / حابس رائحة مياه قناة دش / 50



4078.0A050K.040.1	Ø 50	40 cm	12	24,33
4078.0A050K.050.1	Ø 50	50 cm	12	27,05
4078.0A050K.060.1	Ø 50	60 cm	12	30,10

\* Shower drain / Ø 50 vertical outlet / Stainless body / Stainless grid / Odor blocking by water  
 \* Душ канал / Ø 50 Нижний выход / Нержавеющее тело / Нержавеющая щетка / Гидрозатвор  
 بمصرف سفلي / هيكل و اطار مقاوم للصدأ / حابس رائحة مياه قناة دش / 50

## VEGA LUX SIFONIK



Code Outlet Length Price \$

4079.0Y050K.040.1	Ø 50	40 cm	12	22,75
4079.0Y050K.050.1	Ø 50	50 cm	12	25,45
4079.0Y050K.060.1	Ø 50	60 cm	12	28,50

\* Shower drain / Ø 50 horizontal outlet / Stainless body / Stainless grid / Odor blocking by water  
 \* Душ канал / Ø 50 Боковой выход / Нержавеющее тело / Нержавеющая щетка / Гидрозатвор  
 مصرف جانبي / هيكل و اطار مقاوم للصدأ / حابس رائحة مياه قناة دش / 50

PART NO	PART DESCRIPTION	MATERIAL	PCS
	Stainless Body	AISI 304	1
4079.2	Stainless grid	AISI 304	1
	Odor blocking	PP	1
4079.4	S Siphon	PP	1

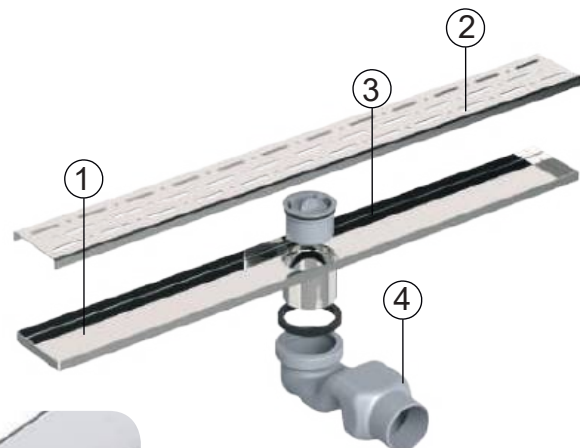

# STYLE SERIES

# h10

## VEGA MESH



Code      Outlet      Length           Price \$

4075.FY050K.040.1	Ø 50	40 cm	12	23,12
4075.FY050K.050.1	Ø 50	50 cm	12	26,18
4075.FY050K.060.1	Ø 50	60 cm	12	28,35

\* Shower drain / Ø 50 horizontal outlet / Stainless body / Stainless grid / Odor blocking by water  
 \* Душ канал / Ø 50 Боковой выход / Нержавеющее тело / Нержавеющая щетка / Гидрозатвор  
 مصرف جانبي / هيكل و اطار مقاوم للصدأ / حابس رائحة مياه      قنائة دش / 50Ø

4075.FA050K.040.1	Ø 50	40 cm	12	23,12
4075.FA050K.050.1	Ø 50	50 cm	12	26,18
4075.FA050K.060.1	Ø 50	60 cm	12	28,35

\* Shower drain / Ø 50 vertical outlet / Stainless body / Stainless grid / Odor blocking by water  
 \* Душ канал / Ø 50 Нижний выход / Нержавеющее тело / Нержавеющая щетка / Гидрозатвор  
 بمصرف سفلي / هيكل و اطار مقاوم للصدأ / حابس رائحة مياه      قنائة دش / 50Ø

## VEGA LUX MESH



Code      Outlet      Length           Price \$

4078.FY050K.040.1	Ø 50	40 cm	12	28,85
4078.FY050K.050.1	Ø 50	50 cm	12	31,77
4078.FY050K.060.1	Ø 50	60 cm	12	35,05

\* Shower drain / Ø 50 horizontal outlet / Stainless body / Stainless grid / Odor blocking by water  
 \* Душ канал / Ø 50 Боковой выход / Нержавеющее тело / Нержавеющая щетка / Гидрозатвор  
 مصرف جانبي / هيكل و اطار مقاوم للصدأ / حابس رائحة مياه      قنائة دش / 50Ø

4078.FA050K.040.1	Ø 50	40 cm	12	28,85
4078.FA050K.050.1	Ø 50	50 cm	12	31,77
4078.FA050K.060.1	Ø 50	60 cm	12	35,05

\* Shower drain / Ø 50 vertical outlet / Stainless body / Stainless grid / Odor blocking by water  
 \* Душ канал / Ø 50 Нижний выход / Нержавеющее тело / Нержавеющая щетка / Гидрозатвор  
 بمصرف سفلي / هيكل و اطار مقاوم للصدأ / حابس رائحة مياه      قنائة دش / 50Ø

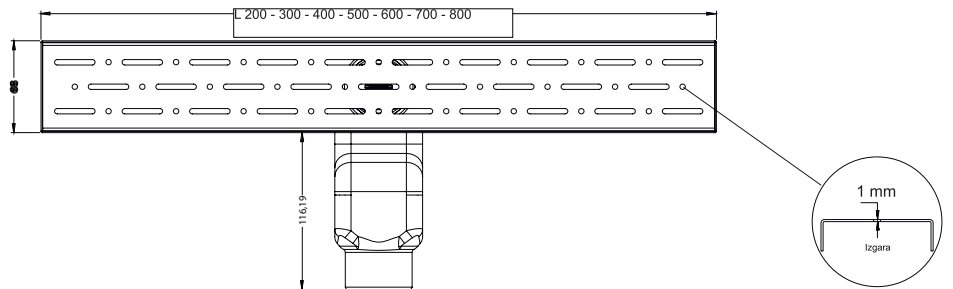
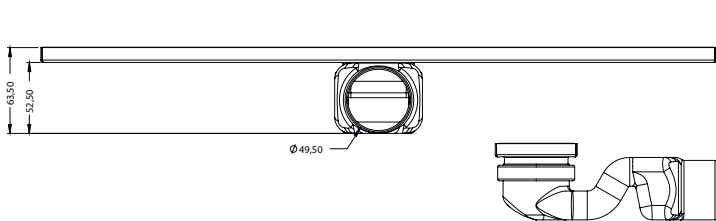

# STANDARD SERIES

# h10

## LINE



Code      Outlet      Length           Price \$

4022.0Y050K.033.1	Ø 50	33 cm	12	15,38
4022.0Y050K.040.1	Ø 50	40 cm	12	16,67
4022.0Y050K.050.1	Ø 50	50 cm	12	18,95
4022.0Y050K.060.1	Ø 50	60 cm	12	23,08
4022.0Y050K.080.1	Ø 50	80 cm	12	25,02

\* Shower drain / Ø 50 side outlet / Plastic body / Stainless grid / Odor blocking by water  
 \* Душ канал / Ø 50 боковой выход / пластичное тело / Нержавеющая щетка / Гидрозатвор  
 قنارة دش / مصرف جانبي / هيكل بلاستيكي / شبكة مقاومة للصدأ / حابيس رائحة المياه

4022.0A050K.033.1	Ø 50	33 cm	12	15,38
4022.0A050K.040.1	Ø 50	40 cm	12	16,67
4022.0A050K.050.1	Ø 50	50 cm	12	18,95
4022.0A050K.060.1	Ø 50	60 cm	12	23,08
4022.0A050K.080.1	Ø 50	80 cm	12	25,02

\* Shower drain / Ø 50 side outlet / Plastic body / Stainless grid / Odor blocking by water  
 \* Душ канал / Ø 50 боковой выход / пластичное тело / Нержавеющая щетка / Гидрозатвор  
 قنارة دش / مصرف جانبي / هيكل بلاستيكي / شبكة مقاومة للصدأ / حابيس رائحة المياه

## LINE GOLD



Code      Outlet      Length           Price \$

4022.0Y050G.033.1	Ø 50	33 cm	12	19,23
4022.0Y050G.040.1	Ø 50	40 cm	12	21,20
4022.0Y050G.050.1	Ø 50	50 cm	12	24,50
4022.0Y050G.060.1	Ø 50	60 cm	12	31,03
4022.0Y050G.080.1	Ø 50	80 cm	12	33,52

\* Shower drain / Ø 50 side outlet / Plastic body / Stainless grid / Odor blocking by water  
 \* Душ канал / Ø 50 боковой выход / пластичное тело / Нержавеющая щетка / Гидрозатвор  
 قنارة دش / مصرف جانبي / هيكل بلاستيكي / شبكة مقاومة للصدأ / حابيس رائحة المياه

4022.0A050G.033.1	Ø 50	33 cm	12	19,23
4022.0A050G.040.1	Ø 50	40 cm	12	21,20
4022.0A050G.050.1	Ø 50	50 cm	12	24,50
4022.0A050G.060.1	Ø 50	60 cm	12	31,03
4022.0A050G.080.1	Ø 50	80 cm	12	33,52

\* Shower drain / Ø 50 side outlet / Plastic body / Stainless grid / Odor blocking by water  
 \* Душ канал / Ø 50 боковой выход / пластичное тело / Нержавеющая щетка / Гидрозатвор  
 قنارة دش / مصرف جانبي / هيكل بلاستيكي / شبكة مقاومة للصدأ / حابيس رائحة المياه

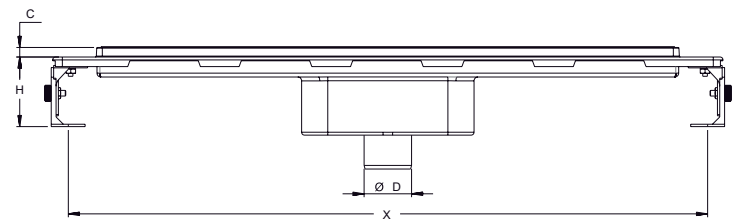
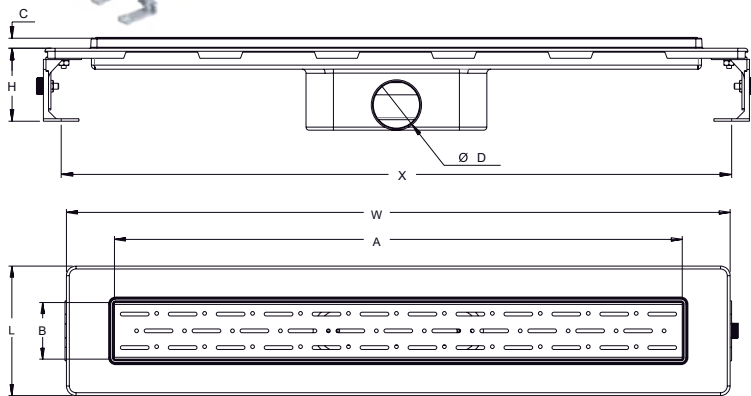

Code	W	L	H	Ø D	A	B	C	X	E
4022.0Y050K.040.1	423	134	72	49.5	330	58	10	385	1
4022.0Y050K.060.1	492	134	72	49.5	400	58	10	456	1
4022.0Y050K.060.1	592	134	72	49.5	500	58	10	556	1.5
4022.0Y050K.060.1	693	134	72	49.5	600	58	10	656	1.5
4022.0Y050K.060.1	893	134	72	49.5	800	58	10	856	1.5

Code	W	L	H	Ø D	A	B	C	X	E
4022.0A050G.040.1	423	134	100	49.5	330	58	10	385	1
4022.0A050G.060.1	492	134	100	49.5	400	58	10	456	1
4022.0A050G.060.1	592	134	100	49.5	500	58	10	556	1.5
4022.0A050G.060.1	693	134	100	49.5	600	58	10	656	1.5
4022.0A050G.060.1	893	134	100	49.5	800	58	10	856	1.5

Table measure "mm"



RAIN

SQUARE

FISH

BAHN

MARYLAND

SOLID



# STANDARD SERIES

# h10

## LINE T.M.

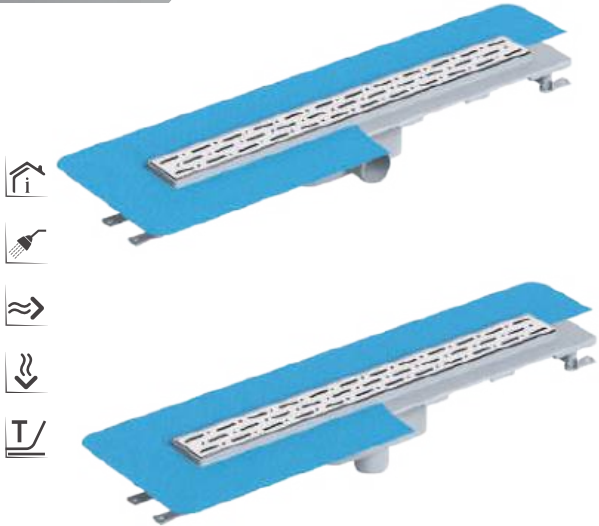

Code      Outlet      Length            Price \$

4022.TY050K.033.I	Ø 50	33 cm	12	17,48
4022.TY050K.040.I	Ø 50	40 cm	12	19,17
4022.TY050K.050.I	Ø 50	50 cm	12	21,75
4022.TY050K.060.I	Ø 50	60 cm	12	26,08
4022.TY050K.080.I	Ø 50	80 cm	12	28,80

\* Shower drain / Ø 50 side outlet / Plastic body / Stainless grid Textile membrane / Odor blocking by water  
 \* Душ канал / Ø 50 боковой выход / пластичное тело / Нержавеющая щетка / Текстиль Мембраны / Гидрозатвор

هيكل بلاستيكي / نسيج شبكة مقاومة للصدأ / حابس رائحة المياه / قناة دش / مصرف جانبي

4022.TA050K.033.I	Ø 50	33 cm	12	17,48
4022.TA050K.040.I	Ø 50	40 cm	12	19,17
4022.TA050K.050.I	Ø 50	50 cm	12	21,75
4022.TA050K.060.I	Ø 50	60 cm	12	26,08
4022.TA050K.080.I	Ø 50	80 cm	12	28,80

\* Shower drain / Ø 50 vertical outlet / Plastic body / Stainless grid Textile membrane / Odor blocking by water  
 \* Душ канал / Ø 50 Нижний выход / пластичное тело / Нержавеющая щетка / Текстиль Мембраны / Гидрозатвор

هيكل بلاستيكي / نسيج شبكة مقاومة للصدأ / حابس رائحة المياه / قناة دش / بمصرف سفلي

## LINE T.M.GOLD

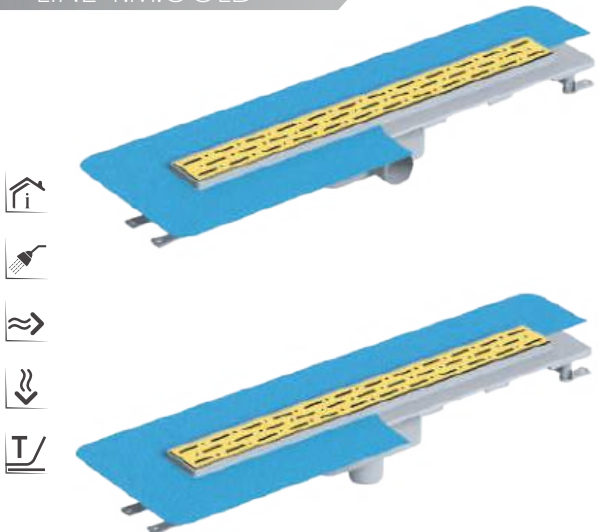

Code      Outlet      Length            Price \$

4022.TY050G.033.I	Ø 50	33 cm	12	21,50
4022.TY050G.040.I	Ø 50	40 cm	12	23,88
4022.TY050G.050.I	Ø 50	50 cm	12	27,50
4022.TY050G.060.I	Ø 50	60 cm	12	34,25
4022.TY050G.080.I	Ø 50	80 cm	12	37,60

\* Shower drain / Ø 50 side outlet / Plastic body / Stainless grid Textile membrane / Odor blocking by water  
 \* Душ канал / Ø 50 боковой выход / пластичное тело / Нержавеющая щетка / Текстиль Мембраны / Гидрозатвор

هيكل بلاستيكي / نسيج شبكة مقاومة للصدأ / حابس رائحة المياه / قناة دش / مصرف جانبي

4022.TA050G.033.I	Ø 50	33 cm	12	21,50
4022.TA050G.040.I	Ø 50	40 cm	12	23,88
4022.TA050G.050.I	Ø 50	50 cm	12	27,50
4022.TA050G.060.I	Ø 50	60 cm	12	34,25
4022.TA050G.080.I	Ø 50	80 cm	12	37,60

\* Shower drain / Ø 50 vertical outlet / Plastic body / Stainless grid Textile membrane / Odor blocking by water  
 \* Душ канал / Ø 50 Нижний выход / пластичное тело / Нержавеющая щетка / Текстиль Мембраны / Гидрозатвор

هيكل بلاستيكي / نسيج شبكة مقاومة للصدأ / حابس رائحة المياه / قناة دش / بمصرف سفلي

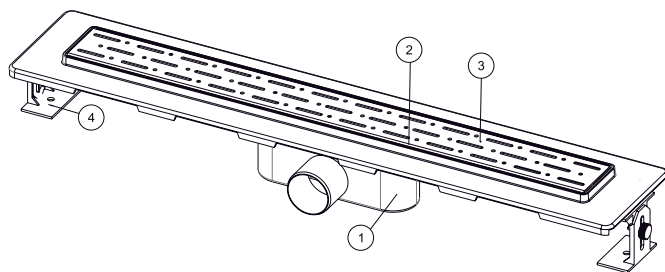

DN 50 side and vertical outlet - compatible with PVC pipe connections, blocking odor by water (36mm). The flow rate is 32 liters/min. Resistant against external chemical effects, operating temperature is between - 30°C and +75°C. The grid is made of 304 grade stainless steel.

With its 304 grade stainless steel grid, it has a quality and stylish-looking. It can be easily applied at floor. With its odor blocking by water support, it prevents the bad smell coming from the installation. With its adjustable height legs, it can be adjusted depending on the screed concrete. High resistance against the organic and inorganic chemicals, resistant against most acidic and vertically aqueous oxidation.

Common use of bathroom shower, hospital and hotel shower areas, locker-room shower areas etc.

Grid patterns can be chosen in gold, bronze or other optional colors in accordance with your desire.

It is not recommended to use high-density cleaners for a long-time.

PART NO	PART DESCRIPTION	MATERIAL	PCS
	Plastic Outlet	ABS	1
4022.2	Odor blocking	ABS	1
	Stainless grid	AISI 304	1
4022.4	HEIGHT ADJUSTABLE LEGS	PP	2



RAIN



SQUARE



FISH



BAHN



MARYLAND



SOLID

# STANDARD SERIES

# h10

## DELUXE



Code Outlet Length  Price \$

4016.0Y050K.033.1	Ø 50	33 cm	12	24,43
4016.0Y050K.040.1	Ø 50	40 cm	12	25,93
4016.0Y050K.050.1	Ø 50	50 cm	12	29,42
4016.0Y050K.060.1	Ø 50	60 cm	12	33,28
4016.0Y050K.080.1	Ø 50	80 cm	12	40,08

\* Shower drain / Ø 50 side outlet / Plastic body / Stainless grid Stainless frame / Odor blocking by water  
 \* Душ канал / Ø 50 боковой выход / пластиковое тело / Нержавеющая щетка / Гидрозатвор  
 هيكل بلاستيكي / شبكة وإطار مقاوم للصدأ / حابس رائحة المياه / قناة دش / بمصرف جانبي

4016.0A050K.033.1	Ø 50	33 cm	12	24,43
4016.0A050K.040.1	Ø 50	40 cm	12	25,93
4016.0A050K.050.1	Ø 50	50 cm	12	29,42
4016.0A050K.060.1	Ø 50	60 cm	12	33,28
4016.0A050K.080.1	Ø 50	80 cm	12	40,08

\* Shower drain / Ø 50 vertical outlet / Plastic body / Stainless grid Stainless frame / Odor blocking by water  
 \* Душ канал / Ø 50 Нижний выход / пластиковое тело / Нержавеющая щетка / Гидрозатвор  
 هيكل بلاستيكي / شبكة وإطار مقاوم للصدأ / حابس رائحة المياه / قناة دش / بمصرف سفلي

## DELUXE T.M.



Code Outlet Length  Price \$

4016.TY050K.033.1	Ø 50	33 cm	12	26,53
4016.TY050K.040.1	Ø 50	40 cm	12	28,42
4016.TY050K.050.1	Ø 50	50 cm	12	32,22
4016.TY050K.060.1	Ø 50	60 cm	12	36,28
4016.TY050K.080.1	Ø 50	80 cm	12	43,87

\* Shower drain / Ø 50 side outlet / Plastic body / Stainless grid Textile membrane / Odor blocking by water  
 \* Душ канал / Ø 50 боковой выход / пластиковое тело / Нержавеющая щетка / Текстиль Мембраны / Гидрозатвор  
 هيكل بلاستيكي / نسيج شبكة مقاومة للصدأ / حابس رائحة المياه / قناة دش / بمصرف جانبي

4016.TA050K.033.1	Ø 50	33 cm	12	26,53
4016.TA050K.040.1	Ø 50	40 cm	12	28,42
4016.TA050K.050.1	Ø 50	50 cm	12	32,22
4016.TA050K.060.1	Ø 50	60 cm	12	36,28
4016.TA050K.080.1	Ø 50	80 cm	12	43,87

\* Shower drain / Ø 50 vertical outlet / Plastic body / Stainless grid Textile membrane / Odor blocking by water  
 \* Душ канал / Ø 50 Нижний выход / пластиковое тело / Нержавеющая щетка / Текстиль Мембраны / Гидрозатвор  
 هيكل بلاستيكي / نسيج شبكة مقاومة للصدأ / حابس رائحة المياه / بمصرف سفلي / قناة دش

Code	W	L	H	Ø D	A	B	C	X	E	B1	A1
4016.0Y050K.040.1	423	134	72	49.5	360	88,9	11,35	385	1	56	325
	492	134	72	49.5	430	88,9	11,35	456	1	56	395
4016.0Y050K.060.1	592	134	72	49.5	530	88,9	11,35	556	1.5	56	495
	693	134	72	49.5	630	88,9	11,35	656	1.5	56	595
	893	134	72	49.5	830	88,9	11,35	856	1.5	56	795

Code	W	L	H	Ø D	A	B	C	X	E	B1	A1
4016.0A050K.040.1	423	134	100	49.5	360	88,9	11,35	385	1	56	325
	492	134	100	49.5	430	88,9	11,35	456	1	56	395
4016.0A050K.060.1	592	134	100	49.5	530	88,9	11,35	556	1.5	56	495
	693	134	100	49.5	630	88,9	11,35	656	1.5	56	595
	893	134	100	49.5	830	88,9	11,35	856	1.5	56	795

Table measure \*mm\*

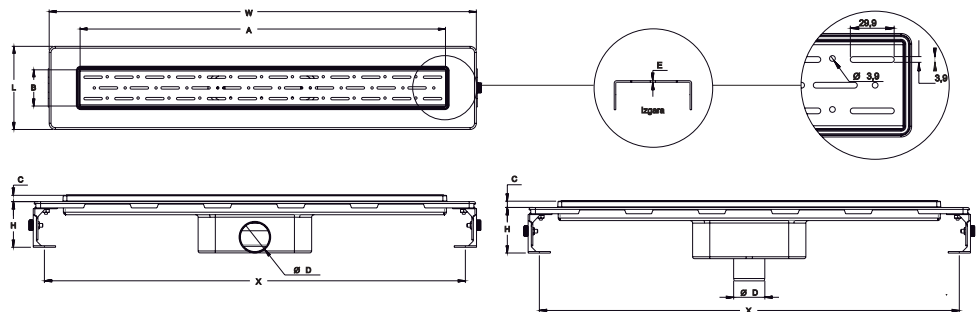

# PRIME SERIES

# h10

## LINE



Code      Outlet      Length           Price \$

4023.OY050K.033.I	Ø 50	33 cm	12	13,78
4023.OY050K.040.I	Ø 50	40 cm	12	15,50
4023.OY050K.050.I	Ø 50	50 cm	12	17,58
4023.OY050K.060.I	Ø 50	60 cm	12	20,38
4023.OY050K.080.I	Ø 50	80 cm	12	24,05

\* Shower drain / Ø 50 horizontal outlet / Plastic body / Stainless grid / Dry odor trap  
 \* Душ канал / Ø 50 Боковой выход / пластичное тело / Нержавеющая щетка / Сухой Затвор  
 هيكل بلاستيكي / شبكة مقاومة للصدأ / حابس رائحة المياه / قنطرة دش / بمصرف جانبي

4023.OA050K.033.I	Ø 50	33 cm	12	13,78
4023.OA050K.040.I	Ø 50	40 cm	12	15,50
4023.OA050K.050.I	Ø 50	50 cm	12	17,58
4023.OA050K.060.I	Ø 50	60 cm	12	20,38
4023.OA050K.080.I	Ø 50	80 cm	12	24,05

\* Shower drain / Ø 50 vertical outlet / Plastic body / Stainless grid / Dry odor trap  
 \* Душ канал / Ø 50 Нижний выход / пластичное тело / Нержавеющая щетка / Сухой Затвор  
 هيكل بلاستيكي / شبكة مقاومة للصدأ / حابس رائحة المياه / قنطرة دش / بمصرف سفلي

## LINE T.M.



Code      Outlet      Length           Price \$

4023.TY050K.033.I	Ø 50	33 cm	12	16,55
4023.TY050K.040.I	Ø 50	40 cm	12	18,53
4023.TY050K.050.I	Ø 50	50 cm	12	21,05
4023.TY050K.060.I	Ø 50	60 cm	12	24,25
4023.TY050K.080.I	Ø 50	80 cm	12	28,65

\* Shower drain / Ø 50 horizontal outlet / Plastic body / Stainless grid / Textile membrane / Dry odor trap  
 \* Душ канал / Ø 50 Боковой выход / пластичное тело / Нержавеющая щетка / Текстиль Мембраны / Сухой Затвор  
 هيكل بلاستيكي / نسيج شبكة مقاومة للصدأ / حابس رائحة المياه / قنطرة دش / بمصرف جانبي

4023.TA050K.033.I	Ø 50	33 cm	12	16,55
4023.TA050K.040.I	Ø 50	40 cm	12	18,53
4023.TA050K.050.I	Ø 50	50 cm	12	21,05
4023.TA050K.060.I	Ø 50	60 cm	12	24,25
4023.TA050K.080.I	Ø 50	80 cm	12	28,65

\* Shower drain / Ø 50 vertical outlet / Plastic body / Stainless grid / Textile membrane / Dry odor trap  
 \* Душ канал / Ø 50 Нижний выход / пластичное тело / Нержавеющая щетка / Текстиль Мембраны / Сухой Затвор  
 هيكل بلاستيكي / نسيج شبكة مقاومة للصدأ / حابس رائحة المياه / قنطرة دش / بمصرف سفلي

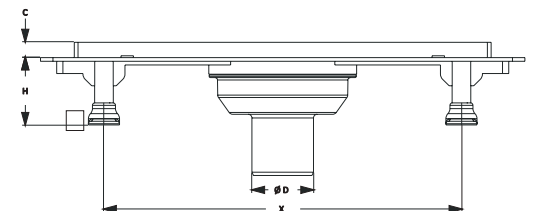
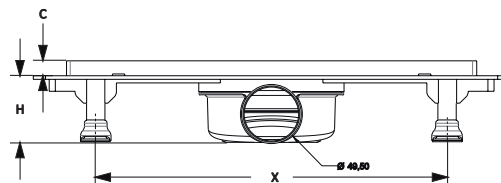
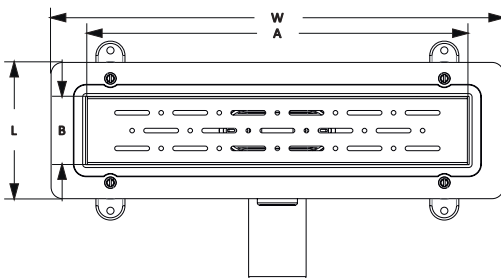

# PRIME SERIES

# h10

## LEGAL

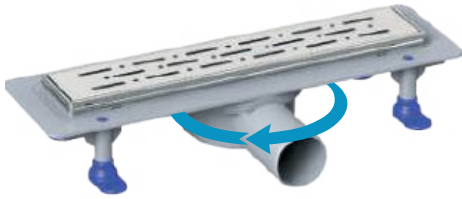

Code Outlet Length Price \$

4024.0Y050K.033.1	Ø 50	33 cm	12	16,72
4024.0Y050K.040.1	Ø 50	40 cm	12	18,53
4024.0Y050K.050.1	Ø 50	50 cm	12	21,92
4024.0Y050K.060.1	Ø 50	60 cm	12	24,47
4024.0Y050K.080.1	Ø 50	80 cm	12	29,00

\* Shower drain / Ø 50 horizontal outlet / Plastic body / Stainless grid / Dry odor trap Steel Frame  
 \* Душ канал / Ø 50 Боковой выход / пластиковое тело / Нержавеющая щетка Сухой Затвор/ Стальная рама

هيكل بلاستيكي / شبكة وإطار مقاوم للصدأ / حابس رائحة المياه / قناة دش / مصرف جانبي

4024.0A050K.033.1	Ø 50	33 cm	12	16,72
4024.0A050K.040.1	Ø 50	40 cm	12	18,53
4024.0A050K.050.1	Ø 50	50 cm	12	21,92
4024.0A050K.060.1	Ø 50	60 cm	12	24,47
4024.0A050K.080.1	Ø 50	80 cm	12	29,00

\* Shower drain / Ø 50 vertical outlet / Plastic body / Stainless grid / Dry odor trap/ Steel Frame  
 \* Душ канал / Ø 50 Нижний выход / пластиковое тело / Нержавеющая щетка /Сухой Затвор/ Стальная рама

هيكل بلاستيكي / شبكة وإطار مقاوم للصدأ / حابس رائحة المياه / قناة دش / بمصرف سفلي

## LEGAL T.M.

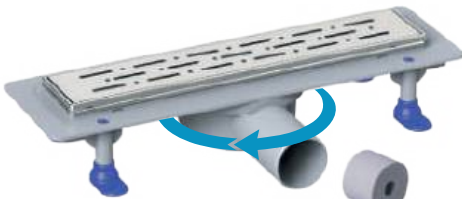

Code Outlet Length Price \$

4024.TY050K.033.1	Ø 50	33 cm	12	20,02
4024.TY050K.040.1	Ø 50	40 cm	12	22,43
4024.TY050K.050.1	Ø 50	50 cm	12	25,38
4024.TY050K.060.1	Ø 50	60 cm	12	28,32
4024.TY050K.080.1	Ø 50	80 cm	12	33,58

\* Shower drain / Ø 50 horizontal outlet / Plastic body / Stainless grid/ Textile membrane Dry odor trap/ Steel Frame  
 \* Душ канал / Ø 50 Боковой выход / пластиковое тело / Нержавеющая щетка Текстиль Мембраны / Сухой Затвор/Стальная рама

قناة دش / مصرف جانبي / هيكل بلاستيكي / شبكة نسيجي وإطار مقاوم للصدأ / حابس رائحة المياه

4024.TA050K.033.1	Ø 50	33 cm	12	20,02
4024.TA050K.040.1	Ø 50	40 cm	12	22,43
4024.TA050K.050.1	Ø 50	50 cm	12	25,38
4024.TA050K.060.1	Ø 50	60 cm	12	28,32
4024.TA050K.080.1	Ø 50	80 cm	12	33,58

\* Shower drain / Ø 50 vertical outlet / Plastic body / Stainless grid Textile membrane / Dry odor trap / Steel Frame  
 \* Душ канал / Ø 50 Нижний выход / пластиковое тело / Нержавеющая щетка Текстиль Мембраны / Сухой Затвор/Стальная рама

قناة دش / بمصرف سفلي / هيكل بلاستيكي / شبكة نسيجي وإطار مقاوم للصدأ / حابس رائحة المياه

	W	L	H	Ø D	A	B	C	X	E
4024.0Y050K.040.1	389	119	55	50	335	64.5	12.5	287	1.2
4024.0Y050K.060.1	454	119	55	50	405	64.5	12.5	387	1.2
4024.0Y050K.060.1	554	119	55	50	505	64.5	12.5	487	1.2
4024.0Y050K.060.1	654	119	55	50	605	64.5	12.5	587	1.2

	W	L	H	Ø D	A	B	C	X	E
4024.0A050K.040.1	389	119	55	50	335	64.5	12.5	287	1.2
4024.0A050K.060.1	454	119	55	50	405	64.5	12.5	387	1.2
4024.0A050K.060.1	554	119	55	50	505	64.5	12.5	487	1.2
4024.0A050K.060.1	654	119	55	50	605	64.5	12.5	587	1.2

Table measure "mm"



# PRIME SERIES

# h10

## DELUXE



Code Outlet Length Price \$

Code	Outlet	Length	Price \$
4025.0Y050K.033.I	Ø 50	33 cm	12, 20,68
4025.0Y050K.040.I	Ø 50	40 cm	12, 22,40
4025.0Y050K.050.I	Ø 50	50 cm	12, 25,32
4025.0Y050K.060.I	Ø 50	60 cm	12, 28,53
4025.0Y050K.080.I	Ø 50	80 cm	12, 33,90

\* Shower drain / Ø 50 horizontal outlet / Plastic body / Stainless grid / Dry odor trap/ Steel Frame

\* Душ канал / Ø 50 Боковой выход / пластиковое тело / Нержавеющая щетка / Сухой Затвор / Стальная рама

قناة دش / مصرف جانبي / هيكل بلاستيكي / شبكة وإطار مقاوم للصدأ / حابس رائحة المياه

Code	Outlet	Length	Price \$
4025.0A050K.033.I	Ø 50	33 cm	12, 20,68
4025.0A050K.040.I	Ø 50	40 cm	12, 22,40
4025.0A050K.050.I	Ø 50	50 cm	12, 25,32
4025.0A050K.060.I	Ø 50	60 cm	12, 28,53
4025.0A050K.080.I	Ø 50	80 cm	12, 33,90

\* Shower drain / Ø 50 vertical outlet / Plastic body / Stainless grid / Dry odor trap/ Steel Frame

\* Душ канал / Ø 50 Нижний выход / пластиковое тело / Нержавеющая щетка / Сухой Затвор / Стальная рама

قناة دش / مصرف سفلي / هيكل بلاستيكي / شبكة وإطار مقاوم للصدأ / حابس رائحة المياه

## DELUXE T.M.

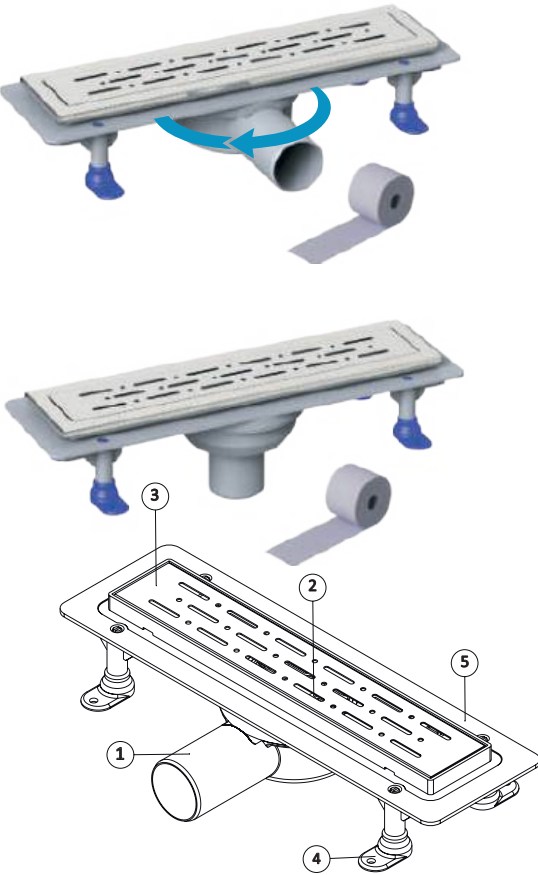

Code Outlet Length Price \$

Code	Outlet	Length	Price \$
4025.TY050K.033.I	Ø 50	33 cm	12, 23,45
4025.TY050K.040.I	Ø 50	40 cm	12, 25,43
4025.TY050K.050.I	Ø 50	50 cm	12, 28,78
4025.TY050K.060.I	Ø 50	60 cm	12, 32,38
4025.TY050K.080.I	Ø 50	80 cm	12, 38,48

\* Shower drain / Ø 50 horizontal outlet / Plastic body / Stainless grid/ Textile membrane / Dry odor trap/ Steel Frame

\* Душ канал / Ø 50 Боковой выход / пластиковое тело / Нержавеющая щетка / Текстиль Мембраны / Сухой Затвор/Стальная рама

قناة دش / مصرف جانبي / هيكل بلاستيكي / شبكة نسيجي وإطار مقاوم للصدأ / حابس رائحة المياه

Code	Outlet	Length	Price \$
4025.TA050K.033.I	Ø 50	33 cm	12, 23,45
4025.TA050K.040.I	Ø 50	40 cm	12, 25,43
4025.TA050K.050.I	Ø 50	50 cm	12, 28,78
4025.TA050K.060.I	Ø 50	60 cm	12, 32,38
4025.TA050K.080.I	Ø 50	80 cm	12, 38,48

\* Shower drain / Ø 50 vertical outlet / Plastic body / Stainless grid Textile membrane / Dry odor trap/ Steel Frame

\* Душ канал / Ø 50 Нижний выход / пластиковое тело / Нержавеющая щетка / Текстиль Мембраны / Сухой Затвор/Стальная рама

قناة دش / مصرف سفلي / هيكل بلاستيكي / شبكة نسيجي وإطار مقاوم للصدأ / حابس رائحة المياه

DN 50 Side ve Vertical Outlet – Pvc boru bağlantılarına uyumlu, sulu tip (36mm) koku önleyiciye sahiptir. Akış hızı 32 lt/dk'dır. Dış kimyasal etkilere daSideim çalışma sıcaklığı -30°+75° arasındadır. Izgarası 304 Quality STAINLESS çeliktir.

304 Quality STAINLESS çelik izgarası sayesinde şık ve Qualityli bir görünüme sahiptir. Duvar dibi uygulamalarda rahatlıkla uygulanabilir. Su tutuculu koku önleyici sayesinde tesisattan gelecek kötü kokuları önler. Yükseltme ayakları sayesinde şapın yüksekliğine göre ayarlama olanağı sağlar.

Organik ve inorganik kimyasallara yüksek daSideim, çoğu asidik ve tuzlu su oksidasyonuna daSideiklidir.

Genel kullanım banyo duşları, hastane ve otel duş alanları, soyunma odaları duş alanları vb.

Izgara modeli olarak isteğinize göre Verticalın, bronz gibi Colorler de üretilmektedir.

Yüksek yoğunluklu temizlik MATERIALlerinin uzun süreli kullanımı tavsiye edilmez.

PART NO	PART DESCRIPTION	MATERIAL	PCS
	Plastic Outlet	ABS	1
4024.2	Odor blocking	ABS	1
	Stainless grid	AISI 304	1
4024.4	Height Adjustable Legs	PP	4
	Plastic Body	PP	1



# PRIME SERIES

# h10

## SCALA



Code

Outlet

Length



Price \$

4026.0Y050K.033.1	Ø 50	33 cm	12	13,32
4026.0Y050K.040.1	Ø 50	40 cm	12	15,07
4026.0Y050K.050.1	Ø 50	50 cm	12	16,88
4026.0Y050K.060.1	Ø 50	60 cm	12	20,78
4026.0Y050K.080.1	Ø 50	80 cm	12	23,80

\* Shower drain / Ø 50 horizontal outlet / Plastic body / Stainless grid / Dry odor trap

\* Душ канал / Ø 50 Боковой выход / пластичное тело / Нержавеющая щетка / Сухой Затвор

هيكل بلاستيكي / شبكة مقاومة للصدأ / حابس رائحة المياه / قناة دش / مصرف جانبي

4026.0A050K.033.1	Ø 50	33 cm	12	13,32
4026.0A050K.040.1	Ø 50	40 cm	12	15,07
4026.0A050K.050.1	Ø 50	50 cm	12	16,88
4026.0A050K.060.1	Ø 50	60 cm	12	20,78
4026.0A050K.080.1	Ø 50	80 cm	12	23,80

\* Shower drain / Ø 50 vertical outlet / Plastic body / Stainless grid / Dry odor trap

\* Душ канал / Ø 50 Нижний выход / пластичное тело / Нержавеющая щетка / Сухой Затвор

هيكل بلاستيكي / شبكة مقاومة للصدأ / حابس رائحة المياه / قناة دش / مصرف سفلي

## SCALA T.M.

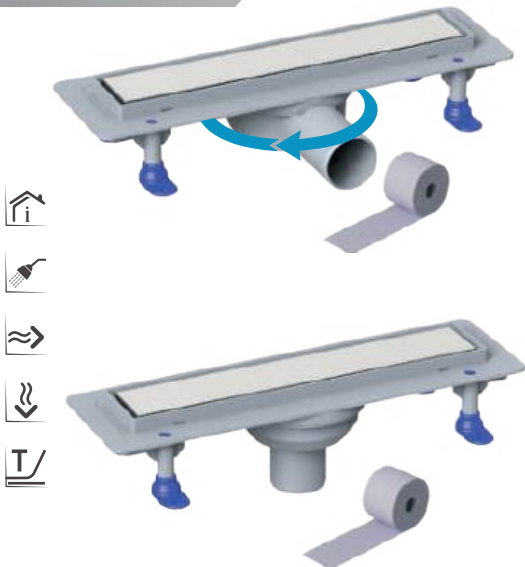

Code

Outlet

Length



Price \$

4026.TY050K.033.1	Ø 50	33 cm	12	16,08
4026.TY050K.040.1	Ø 50	40 cm	12	18,10
4026.TY050K.050.1	Ø 50	50 cm	12	20,35
4026.TY050K.060.1	Ø 50	60 cm	12	22,63
4026.TY050K.080.1	Ø 50	80 cm	12	28,38

\* Shower drain / Ø 50 horizontal outlet / Plastic body / Stainless grid / Textile membrane / Dry odor trap

\* Душ канал / Ø 50 Боковой выход / пластичное тело / Нержавеющая щетка / Текстиль Мембраны / Сухой Затвор

هيكل بلاستيكي / نسيج شبكة مقاومة للصدأ / حابس رائحة المياه / قناة دش / مصرف جانبي

4026.TA050K.033.1	Ø 50	33 cm	12	16,08
4026.TA050K.040.1	Ø 50	40 cm	12	18,10
4026.TA050K.050.1	Ø 50	50 cm	12	20,35
4026.TA050K.060.1	Ø 50	60 cm	12	22,63
4026.TA050K.080.1	Ø 50	80 cm	12	28,38

\* Shower drain / Ø 50 vertical outlet / Plastic body / Stainless grid / Textile membrane / Dry odor trap

\* Душ канал / Ø 50 Нижний выход / пластичное тело / Нержавеющая щетка / Текстиль Мембраны / Сухой Затвор

هيكل بلاستيكي / نسيج شبكة مقاومة للصدأ / حابس رائحة المياه / قناة دش / مصرف سفلي

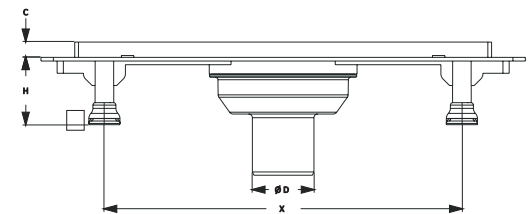
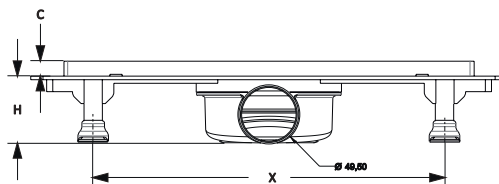
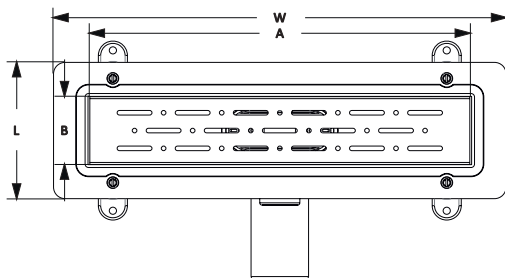

	W	L	H	Ø D	A	B	C	X	E
4024.0Y050K.040.1	389	119	55	50	335	64.5	12.5	287	1.2
4024.0Y050K.060.1	454	119	55	50	405	64.5	12.5	387	1.2
4024.0Y050K.060.1	554	119	55	50	505	64.5	12.5	487	1.2
4024.0Y050K.060.1	654	119	55	50	605	64.5	12.5	587	1.2

	W	L	H	Ø D	A	B	C	X	E
4024.0A050K.040.1	389	119	55	50	335	64.5	12.5	287	1.2
4024.0A050K.060.1	454	119	55	50	405	64.5	12.5	387	1.2
4024.0A050K.060.1	554	119	55	50	505	64.5	12.5	487	1.2
4024.0A050K.060.1	654	119	55	50	605	64.5	12.5	587	1.2

# PRIME SERIES

# h10

## SCALA LEGAL



Code Outlet Length  Price \$

4027.0Y050K.033.1	Ø 50	33 cm	12	17,55
4027.0Y050K.040.1	Ø 50	40 cm	12	18,97
4027.0Y050K.050.1	Ø 50	50 cm	12	21,22
4027.0Y050K.060.1	Ø 50	60 cm	12	23,53
4027.0Y050K.080.1	Ø 50	80 cm	12	29,43

\* Shower drain / Ø 50 horizontal outlet / Plastic body / Stainless grid / Dry odor trap / Steel Frame  
 \* Душ канал / Ø 50 Боковой выход / пластиковое тело / Нержавеющая щетка / Сухой Затвор / Стальная рама

قناة دش / مصرف جانبي / هيكل بلاستيكي / شبكة وإطار مقاوم للصدأ / حابس رائحة المياه

4027.0A050K.033.1	Ø 50	33 cm	12	17,55
4027.0A050K.040.1	Ø 50	40 cm	12	18,97
4027.0A050K.050.1	Ø 50	50 cm	12	21,22
4027.0A050K.060.1	Ø 50	60 cm	12	23,53
4027.0A050K.080.1	Ø 50	80 cm	12	29,43

\* Shower drain / Ø 50 vertical outlet / Plastic body / Stainless grid / Dry odor trap / Steel Frame  
 \* Душ канал / Ø 50 Нижний выход / пластиковое тело / Нержавеющая щетка / Сухой Затвор / Стальная рама

قناة دش / بمصرف سفلي / هيكل بلاستيكي / شبكة وإطار مقاوم للصدأ / حابس رائحة المياه

## SCALA LEGAL T.M.



Code Outlet Length  Price \$

4027.TY050K.033.1	Ø 50	33 cm	12	19,55
4027.TY050K.040.1	Ø 50	40 cm	12	22,00
4027.TY050K.050.1	Ø 50	50 cm	12	24,68
4027.TY050K.060.1	Ø 50	60 cm	12	27,40
4027.TY050K.080.1	Ø 50	80 cm	12	34,02

\* Shower drain / Ø 50 horizontal outlet / Plastic body / Stainless grid / Textile membrane / Dry odor trap / Steel Frame  
 \* Душ канал / Ø 50 Боковой выход / пластиковое тело / Нержавеющая щетка / Текстиль Мембраны / Сухой Затвор / Стальная рама

قناة دش / مصرف جانبي / هيكل بلاستيكي / شبكة نسيجي وإطار مقاوم للصدأ / حابس رائحة المياه

4027.TA050K.033.1	Ø 50	33 cm	12	19,55
4027.TA050K.040.1	Ø 50	40 cm	12	22,00
4027.TA050K.050.1	Ø 50	50 cm	12	24,68
4027.TA050K.060.1	Ø 50	60 cm	12	27,40
4027.TA050K.080.1	Ø 50	80 cm	12	34,02

\* Shower drain / Ø 50 vertical outlet / Plastic body / Stainless grid / Textile membrane / Dry odor trap / Steel Frame  
 \* Душ канал / Ø 50 Нижний выход / пластиковое тело / Нержавеющая щетка / Текстиль Мембраны / Сухой Затвор / Стальная рама

قناة دش / بمصرف سفلي / هيكل بلاستيكي / شبكة نسيجي وإطار مقاوم للصدأ / حابس رائحة المياه

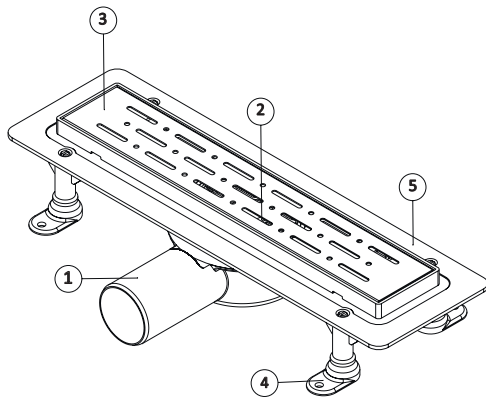

PART NO	PART DESCRIPTION	MATERIAL	PCS
	Plastic Outlet	ABS	1
4024.2	Odor blocking	ABS	1
	Stainless grid	AISI 304	1
4024.4	Height Adjustable Legs	PP	4
	Plastic Body	PP	1

DN 50 side and vertical outlet - compatible with PVC pipe connections, blocking odor by water (36mm). The flow rate is 32 liters/min.

Resistant against external chemical effects, operating temperature is between -30°C and +75°C. The grid is made of 304 grade stainless steel.

With its 304 grade stainless steel grid, it has a quality and stylish-looking. It can be easily applied at floor. With its odor blocking by water support, it prevents the bad smell coming from the installation. With its adjustable height legs, it can be adjusted depending on the screed concrete. High resistance against the organic and inorganic chemicals, resistant against most acidic and vertically aqueous oxidation.

Common use of bathroom shower, hospital and hotel shower areas, locker-room shower areas etc.

Grid patterns can be chosen in gold, bronze or other optional colors in accordance with your desire.

It is not recommended to use high-density cleaners for a long-time.

# PRIME SERIES

# h10

## SCALA DELUXE



Code      Outlet      Length           Price \$

4028.0Y050K.033.1	Ø 50	33 cm	12	20,20
4028.0Y050K.040.1	Ø 50	40 cm	12	21,95
4028.0Y050K.050.1	Ø 50	50 cm	12	24,62
4028.0Y050K.060.1	Ø 50	60 cm	12	27,62
4028.0Y050K.080.1	Ø 50	80 cm	12	34,33

\* Shower drain / Ø 50 horizontal outlet / Plastic body / Stainless grid / Dry odor trap/ Steel Frame  
 \* Душ канал / Ø 50 Боковой выход / пластиковое тело / Нержавеющая щетка Сухой Затвор/ Стальная рама

هيكال بلاستيكي / شبكة وإطار مقاوم للصدأ / حابيس رائحة المياه / قناة دش / مصرف جانبي

4028.0A050K.033.1	Ø 50	33 cm	12	20,20
4028.0A050K.040.1	Ø 50	40 cm	12	21,95
4028.0A050K.050.1	Ø 50	50 cm	12	24,62
4028.0A050K.060.1	Ø 50	60 cm	12	27,62
4028.0A050K.080.1	Ø 50	80 cm	12	34,33

\* Shower drain / Ø 50 vertical outlet / Plastic body / Stainless grid / Dry odor trap Steel Frame  
 \* Душ канал / Ø 50 Нижний выход / пластиковое тело / Нержавеющая щетка Сухой Затвор / Стальная рама

هيكال بلاستيكي / شبكة وإطار مقاوم للصدأ / حابيس رائحة المياه / قناة دش / بمصرف سفلي

## SCALA DELUXE T.M.

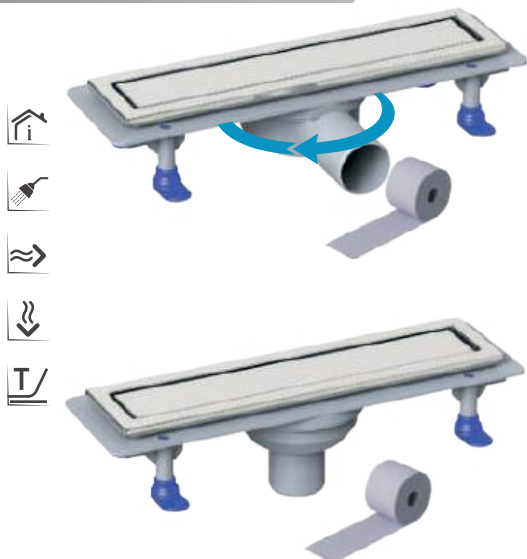

Code      Outlet      Length           Price \$

4028.TY050K.033.1	Ø 50	33 cm	12	22,98
4028.TY050K.040.1	Ø 50	40 cm	12	24,98
4028.TY050K.050.1	Ø 50	50 cm	12	28,08
4028.TY050K.060.1	Ø 50	60 cm	12	31,47
4028.TY050K.080.1	Ø 50	80 cm	12	38,92

\* Shower drain / Ø 50 horizontal outlet / Plastic body / Stainless grid/ Textile membrane / Dry odor trap/ Steel Frame  
 \* Душ канал / Ø 50 Боковой выход / пластиковое тело / Нержавеющая щетка Текстиль Мембраны / Сухой Затвор/Стальная рама

هيكال بلاستيكي / شبكة نسيجي وإطار مقاوم للصدأ / حابيس رائحة المياه / قناة دش / مصرف جانبي

4028.TA050K.033.1	Ø 50	33 cm	12	22,98
4028.TA050K.040.1	Ø 50	40 cm	12	24,98
4028.TA050K.050.1	Ø 50	50 cm	12	28,08
4028.TA050K.060.1	Ø 50	60 cm	12	31,47
4028.TA050K.080.1	Ø 50	80 cm	12	38,92

\* Shower drain / Ø 50 vertical outlet / Plastic body / Stainless grid Textile membrane / Dry odor trap/ Steel Frame  
 \* Душ канал / Ø 50 Нижний выход / пластиковое тело / Нержавеющая щетка /Текстиль Мембраны / Сухой Затвор/Стальная рама

هيكال بلاستيكي / شبكة نسيجي وإطار مقاوم للصدأ / حابيس رائحة المياه / قناة دش / بمصرف سفلي

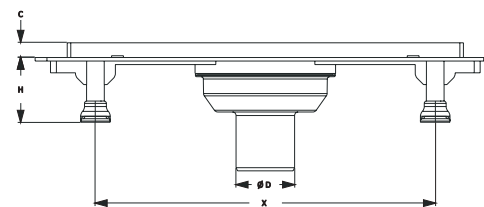
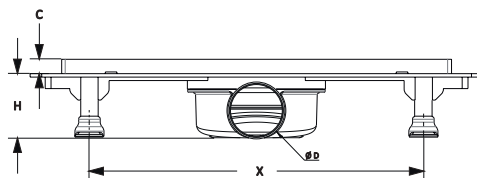
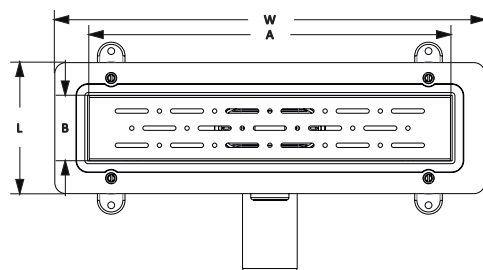

DN 50 side and vertical outlet - compatible with PVC pipe connections, blocking odor by water (36mm). The flow rate is 32 liters/min.

Resistant against external chemical effects, operating temperature is between -30°C and +75°C. The grid is made of 304 grade stainless steel.

With its 304 grade stainless steel grid, it has a quality and stylish-looking. It can be easily applied at floor. With its odor blocking by water support, it prevents the bad smell coming from the installation. With its adjustable height legs, it can be adjusted depending on the screed concrete. High resistance against the organic and inorganic chemicals, resistant against most acidic and vertically aqueous oxidation.

Common use of bathroom shower, hospital and hotel shower areas, locker-room shower areas etc.

Grid patterns can be chosen in gold, bronze or other optional colors in accordance with your desire.

It is not recommended to use high-density cleaners for a long-time.

	W	L	H	Ø D	A	B	C	X	E
4028.0Y050K.040.1	389	119	55	50	335	64.5	12.5	287	1.2
	454	119	55	50	405	64.5	12.5	387	1.2
	554	119	55	50	505	64.5	12.5	487	1.2
4028.0Y050K.060.1	654	119	55	50	605	64.5	12.5	587	1.2

	W	L	H	Ø D	A	B	C	X	E
4028.0A050K.040.1	389	119	55	50	335	64.5	12.5	287	1.2
	454	119	55	50	405	64.5	12.5	387	1.2
	554	119	55	50	505	64.5	12.5	487	1.2
4028.0A050K.060.1	654	119	55	50	605	64.5	12.5	587	1.2

Table measure \*mm\*



# TREND SERIES

# h10

## LINE



Code      Outlet      Length           Price \$

4033.0Y050K.033.1	Ø 50	33 cm	12	23,67
4033.0Y050K.040.1	Ø 50	40 cm	12	26,15
4033.0Y050K.050.1	Ø 50	50 cm	12	30,17
4033.0Y050K.060.1	Ø 50	60 cm	12	34,48
4033.0Y050K.080.1	Ø 50	80 cm	12	40,77

\* Shower drain / Ø 50 side outlet / Plastic body / Adjustable height stainless frame / Odor blocking by water  
 \* Душ канал / Ø 50 боковой выход / пластичное тело С регулировкой высоты / Нержавеющая щетка / Гидрозатвор

قناة دش / مصرف جانبي / هيكل بلاستيكي / ارتفاع قابل للتعديل مقاوم للصدأ إطار من الصلب حابس رائحة المياه

4033.0A050K.033.1	Ø 50	33 cm	12	23,67
4033.0A050K.040.1	Ø 50	40 cm	12	26,15
4033.0A050K.050.1	Ø 50	50 cm	12	30,17
4033.0A050K.060.1	Ø 50	60 cm	12	34,48
4033.0A050K.080.1	Ø 50	80 cm	12	40,77

\* Shower drain / Ø 50 vertical outlet / Plastic body Adjustable Height Stainless frame / Odor blocking by water  
 \* Душ канал / Ø 50 Нижний выход / пластичное тело С регулировкой высоты / Нержавеющая щетка / Гидрозатвор

قناة دش / بمصرف سفلي / هيكل بلاستيكي / ارتفاع قابل للتعديل مقاوم للصدأ إطار من الصلب حابس رائحة المياه

## LINE GOLD



Code      Outlet      Length           Price \$

4033.0Y050G.033.1	Ø 50	33 cm	12	33,93
4033.0Y050G.040.1	Ø 50	40 cm	12	38,28
4033.0Y050G.050.1	Ø 50	50 cm	12	45,57
4033.0Y050G.060.1	Ø 50	60 cm	12	52,67
4033.0Y050G.080.1	Ø 50	80 cm	12	64,15

\* Shower drain / Ø 50 side outlet / Plastic body / Adjustable height stainless frame / Odor blocking by water  
 \* Душ канал / Ø 50 боковой выход / пластичное тело С регулировкой высоты / Нержавеющая щетка / Гидрозатвор

قناة دش / مصرف جانبي / هيكل بلاستيكي / ارتفاع قابل للتعديل مقاوم للصدأ إطار من الصلب حابس رائحة المياه

4033.0A050G.033.1	Ø 50	33 cm	12	33,93
4033.0A050G.040.1	Ø 50	40 cm	12	38,28
4033.0A050G.050.1	Ø 50	50 cm	12	45,57
4033.0A050G.060.1	Ø 50	60 cm	12	52,67
4033.0A050G.080.1	Ø 50	80 cm	12	64,15

\* Shower drain / Ø 50 vertical outlet / Plastic body Adjustable Height Stainless frame / Odor blocking by water  
 \* Душ канал / Ø 50 Нижний выход / пластичное тело С регулировкой высоты / Нержавеющая щетка / Гидрозатвор

قناة دش / بمصرف سفلي / هيكل بلاستيكي / ارتفاع قابل للتعديل مقاوم للصدأ إطار من الصلب حابس رائحة المياه

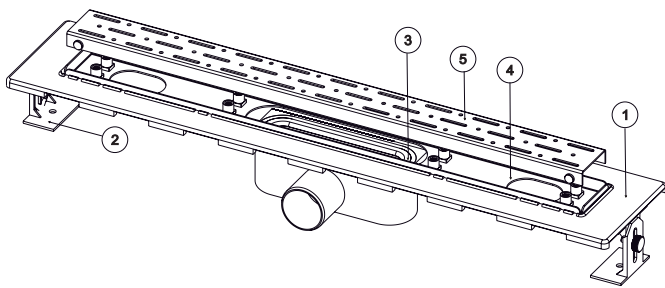

DN 50 side and vertical outlet - compatible with PVC pipe connections, blocking odor by water (36mm). The flow rate is 32 liters/min.

Resistant against external chemical effects, operating temperature is between -30°C and +75°C. The grid is made of 304 grade stainless steel.

With its 304 grade stainless steel grid, it has a quality and stylish-looking. It can be easily applied at floor. With its odor blocking by water support, it prevents the bad smell coming from the installation. With its adjustable height legs, it can be adjusted depending on the screed concrete. High resistance against the organic and inorganic chemicals, resistant against most acidic and vertically aqueous oxidation.

Common use of bathroom shower, hospital and hotel shower areas, locker-room shower areas etc.

Grid patterns can be chosen in gold, bronze or other optional colors in accordance with your desire.

It is not recommended to use high-density cleaners for a long-time.

PART NO	PART DESCRIPTION	MATERIAL	PCS
	Plastic body	ABS	1
4033.2	Height Adjustable Legs	PP	2
	Odor blocking	ABS	1
4033.4	Height Adjustable Frame	AISI 304	1
	Stainless grid	AISI 304	1



# TREND SERIES

# h10

## LINE T.M.

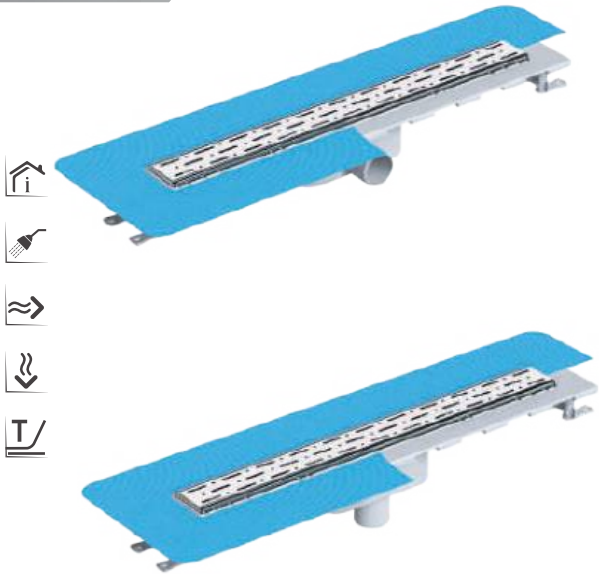

Code      Outlet      Length            Price \$

4033.TY050K.033.I	Ø 50	33 cm	12	25,63
4033.TY050K.040.I	Ø 50	40 cm	12	28,50
4033.TY050K.050.I	Ø 50	50 cm	12	32,78
4033.TY050K.060.I	Ø 50	60 cm	12	37,30
4033.TY050K.080.I	Ø 50	80 cm	12	44,33

\* Shower drain / Ø 50 side outlet / Plastic body / Adjustable height stainless frame / Textile membrane / Odor blocking by water

\* Душ канал / Ø 50 боковой выход / пластичное тело / С регулировкой высоты / Нержавеющая щетка / Текстиль Мембраны / Гидрозащитвор

قناة دش / بمصرف جانبي / هيكل بلاستيكي / ارتفاع قابل للتعديل للمقاوم للصدأ نسيجي / إطار من الصلب / حابس رائحة المياه

4033.TA050K.033.I	Ø 50	33 cm	12	25,63
4033.TA050K.040.I	Ø 50	40 cm	12	28,50
4033.TA050K.050.I	Ø 50	50 cm	12	32,78
4033.TA050K.060.I	Ø 50	60 cm	12	37,30
4033.TA050K.080.I	Ø 50	80 cm	12	44,33

\* Shower drain / Ø 50 vertical outlet / Plastic body / Adjustable height stainless frame / Textile membrane / Odor blocking by water

\* Душ канал / Ø 50 Нижний выход / пластичное тело / С регулировкой высоты / Нержавеющая щетка / Текстиль Мембраны / Гидрозащитвор

قناة دش / بمصرف سفلي / هيكل بلاستيكي / ارتفاع قابل للتعديل للمقاوم للصدأ نسيجي / إطار من الصلب / حابس رائحة المياه

## LINE T.M.GOLD

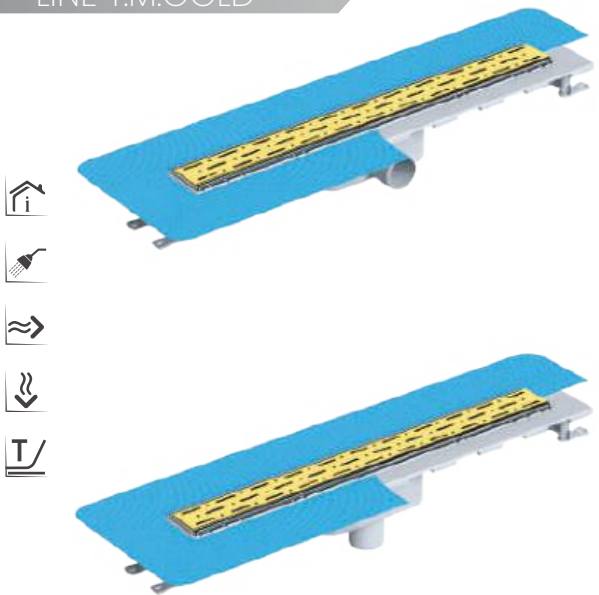

Code      Outlet      Length            Price \$

4033.TY050G.033.I	Ø 50	33 cm	12	36,73
4033.TY050G.040.I	Ø 50	40 cm	12	41,50
4033.TY050G.050.I	Ø 50	50 cm	12	48,58
4033.TY050G.060.I	Ø 50	60 cm	12	55,88
4033.TY050G.080.I	Ø 50	80 cm	12	68,23

\* Shower drain / Ø 50 side outlet / Plastic body / Adjustable height stainless frame / Textile membrane / Odor blocking by water

\* Душ канал / Ø 50 боковой выход / пластичное тело / С регулировкой высоты / Нержавеющая щетка / Текстиль Мембраны / Гидрозащитвор

قناة دش / بمصرف جانبي / هيكل بلاستيكي / ارتفاع قابل للتعديل للمقاوم للصدأ نسيجي / إطار من الصلب / حابس رائحة المياه

4033.TA050G.033.I	Ø 50	33 cm	12	36,73
4033.TA050G.040.I	Ø 50	40 cm	12	41,50
4033.TA050G.050.I	Ø 50	50 cm	12	48,58
4033.TA050G.060.I	Ø 50	60 cm	12	55,88
4033.TA050G.080.I	Ø 50	80 cm	12	68,23

\* Shower drain / Ø 50 vertical outlet / Plastic body / Adjustable height stainless frame / Textile membrane / Odor blocking by water

\* Душ канал / Ø 50 Нижний выход / пластичное тело / С регулировкой высоты / Нержавеющая щетка / Текстиль Мембраны / Гидрозащитвор

قناة دش / بمصرف سفلي / هيكل بلاستيكي / ارتفاع قابل للتعديل للمقاوم للصدأ نسيجي / إطار من الصلب / حابس رائحة المياه

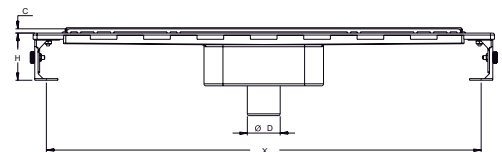
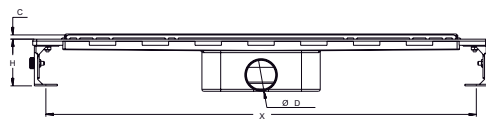
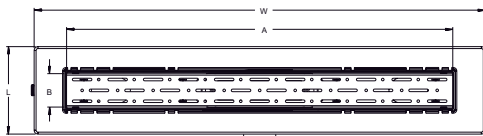

Code	W	L	H	Ø D	A	B	C	X	E
4033.TA050K.040.1	423	134	100	49.5	330	54	8	385	1.5
4033.TA050K.060.1	492	134	100	49.5	400	54	8	456	1.5
	592	134	100	49.5	500	54	8	556	1.5
	693	134	100	49.5	600	54	8	656	1.5
	893	134	100	49.5	800	54	8	856	1.5

Table measure "mm"

Code	W	L	H	Ø D	A	B	C	X	E
4033.TY050K.040.1	423	134	72	49.5	330	54	8	385	1.5
4033.TY050K.060.1	492	134	72	49.5	400	54	8	456	1.5
	592	134	72	49.5	500	54	8	556	1.5
	693	134	72	49.5	600	54	8	656	1.5
	893	134	72	49.5	800	54	8	856	1.5



# ELIT SERIES

# h10

## LEGAL



Code Outlet Length Price \$

4043.0Y050K.033.1	Ø 50	33 cm	12	40,77
4043.0Y050K.040.1	Ø 50	40 cm	12	44,70
4043.0Y050K.050.1	Ø 50	50 cm	12	50,43
4043.0Y050K.060.1	Ø 50	60 cm	12	56,53
4043.0Y050K.080.1	Ø 50	80 cm	12	66,88

\* Shower drain / Ø 50 side outlet / Stainless body / Adjustable height stainless frame / Odor blocking by water  
 \* Душ канал / Ø 50 боковой выход / Корпус Из Нержавеющей С регулировкой высоты / Нержавеющая щетка / Гидрозатвор  
 قنارة دش / بمصرف جانبي / هيكل مقاوم للصدأ / ارتفاع الإطار المقاوم للصدأ / حابيس رائحة المياه

4043.0A050K.033.1	Ø 50	33 cm	12	40,77
4043.0A050K.040.1	Ø 50	40 cm	12	44,70
4043.0A050K.050.1	Ø 50	50 cm	12	50,43
4043.0A050K.060.1	Ø 50	60 cm	12	56,53
4043.0A050K.080.1	Ø 50	80 cm	12	66,88

\* Shower drain / Ø 50 vertical outlet / Stainless body Adjustable height stainless frame / Odor blocking by water  
 \* Душ канал / Ø 50 Нижний выход / Корпус Из Нержавеющей С регулировкой высоты / Нержавеющая щетка / Гидрозатвор  
 قنارة دش / بمصرف سفلي / هيكل مقاوم للصدأ / ارتفاع الإطار المقاوم للصدأ / حابيس رائحة المياه

## LEGAL GOLD

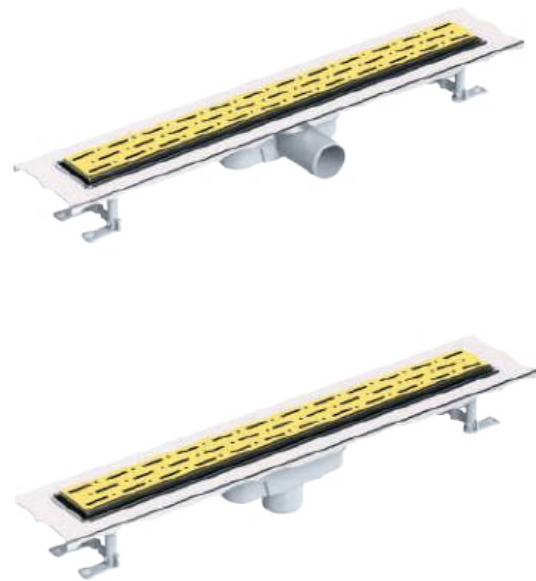

Code Outlet Length Price \$

4043.0Y050G.033.1	Ø 50	33 cm	12	46,85
4043.0Y050G.040.1	Ø 50	40 cm	12	51,50
4043.0Y050G.050.1	Ø 50	50 cm	12	58,33
4043.0Y050G.060.1	Ø 50	60 cm	12	65,60
4043.0Y050G.080.1	Ø 50	80 cm	12	77,98

\* Shower drain / Ø 50 side outlet / Stainless body / Adjustable height stainless frame / Odor blocking by water  
 \* Душ канал / Ø 50 боковой выход / Корпус Из Нержавеющей С регулировкой высоты / Нержавеющая щетка / Гидрозатвор  
 قنارة دش / بمصرف جانبي / هيكل مقاوم للصدأ / ارتفاع الإطار المقاوم للصدأ / حابيس رائحة المياه

4043.0A050G.033.1	Ø 50	33 cm	12	46,85
4043.0A050G.040.1	Ø 50	40 cm	12	51,50
4043.0A050G.050.1	Ø 50	50 cm	12	58,33
4043.0A050G.060.1	Ø 50	60 cm	12	65,60
4043.0A050G.080.1	Ø 50	80 cm	12	77,98

\* Shower drain / Ø 50 vertical outlet / Stainless body Adjustable height stainless frame / Odor blocking by water  
 \* Душ канал / Ø 50 Нижний выход / Корпус Из Нержавеющей С регулировкой высоты / Нержавеющая щетка / Гидрозатвор  
 قنارة دش / بمصرف سفلي / هيكل مقاوم للصدأ / ارتفاع الإطار المقاوم للصدأ / حابيس رائحة المياه

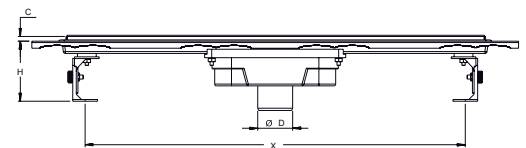
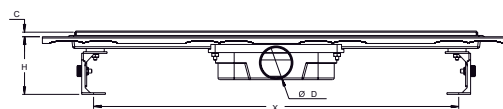
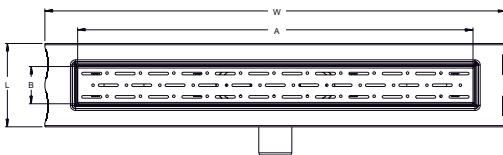

Code	W	L	H	Ø D	A	B	C	X	E
4043.0Y050K.040.1	423	134	85	49.5	330	54	8	385	1.5
	492	134	85	49.5	400	54	8	456	1.5
	592	134	85	49.5	500	54	8	556	1.5
4043.0Y050K.060.1	693	134	85	49.5	600	54	8	656	1.5
	893	134	85	49.5	800	54	8	856	1.5

Code	W	L	H	Ø D	A	B	C	X	E
4043.0A050K.040.1	423	134	100	49.5	330	54	8	385	1.5
	492	134	100	49.5	400	54	8	456	1.5
	592	134	100	49.5	500	54	8	556	1.5
4043.0A050K.060.1	693	134	100	49.5	600	54	8	656	1.5
	893	134	100	49.5	800	54	8	856	1.5

Table measure "mm"



# ELIT SERIES

# h10

## LEGAL T.M.



Code Outlet Length Price \$

4043.TY050K.033.I	Ø 50	33 cm	12	42,87
4043.TY050K.040.I	Ø 50	40 cm	12	47,20
4043.TY050K.050.I	Ø 50	50 cm	12	113,30
4043.TY050K.060.I	Ø 50	60 cm	12	59,53
4043.TY050K.080.I	Ø 50	80 cm	12	70,68

\* Shower drain / Ø 50 side outlet / Stainless body / Adjustable height stainless frame / Textile membrane / Odor blocking by water

\* Душ канал / Ø 50 боковой выход / Корпус Из Нержавеющей / регулируемые по высоте сетки из нержавеющей стали / Текстиль Мембраны / Гидрозатвор

قناة دش / مصرف جانبي / هيكل مقاوم للصدأ / وعيار ارتفاع الإطار المقاوم للصدأ / بغشاء نسيجي حابس رائحة المياه

4043.TA050K.033.I	Ø 50	33 cm	12	42,87
4043.TA050K.040.I	Ø 50	40 cm	12	47,20
4043.TA050K.050.I	Ø 50	50 cm	12	113,30
4043.TA050K.060.I	Ø 50	60 cm	12	59,53
4043.TA050K.080.I	Ø 50	80 cm	12	70,68

\* Shower drain / Ø 50 vertical outlet / Stainless body / Adjustable height stainless frame / Textile membrane / Odor blocking by water

\* Душ канал / Ø 50 Нижний выход / Корпус Из Нержавеющей / регулируемые по высоте сетки из нержавеющей стали / Текстиль Мембраны / Гидрозатвор

قناة دش / مصرف سفلي / هيكل مقاوم للصدأ / وعيار ارتفاع الإطار المقاوم للصدأ / بغشاء نسيجي حابس رائحة المياه

## LEGAL T.M.GOLD

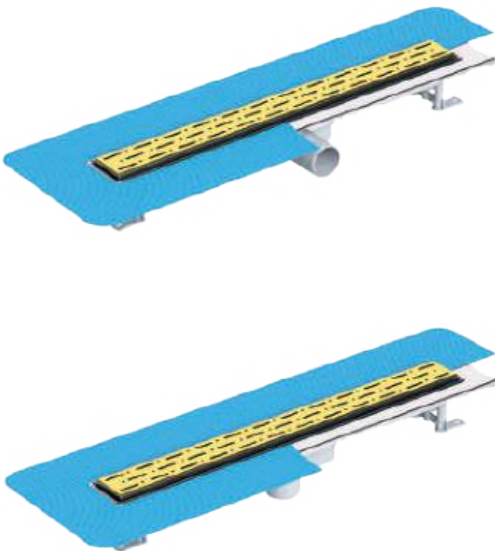

Code Outlet Length Price \$

4043.TY050G.033.I	Ø 50	33 cm	12	45,53
4043.TY050G.040.I	Ø 50	40 cm	12	50,87
4043.TY050G.050.I	Ø 50	50 cm	12	57,18
4043.TY050G.060.I	Ø 50	60 cm	12	64,30
4043.TY050G.080.I	Ø 50	80 cm	12	76,90

\* Shower drain / Ø 50 side outlet / Stainless body / Adjustable height stainless frame / Textile membrane / Odor blocking by water

\* Душ канал / Ø 50 боковой выход / Корпус Из Нержавеющей / регулируемые по высоте сетки из нержавеющей стали / Текстиль Мембраны / Гидрозатвор

قناة دش / مصرف جانبي / هيكل مقاوم للصدأ / وعيار ارتفاع الإطار المقاوم للصدأ / بغشاء نسيجي حابس رائحة المياه

4043.TA050G.033.I	Ø 50	33 cm	12	45,53
4043.TA050G.040.I	Ø 50	40 cm	12	50,87
4043.TA050G.050.I	Ø 50	50 cm	12	57,18
4043.TA050G.060.I	Ø 50	60 cm	12	64,30
4043.TA050G.080.I	Ø 50	80 cm	12	76,90

\* Shower drain / Ø 50 vertical outlet / Stainless body / Adjustable height stainless frame / Textile membrane / Odor blocking by water

\* Душ канал / Ø 50 Нижний выход / Корпус Из Нержавеющей / регулируемые по высоте сетки из нержавеющей стали / Текстиль Мембраны / Гидрозатвор

قناة دش / مصرف سفلي / هيكل مقاوم للصدأ / وعيار ارتفاع الإطار المقاوم للصدأ / بغشاء نسيجي حابس رائحة المياه

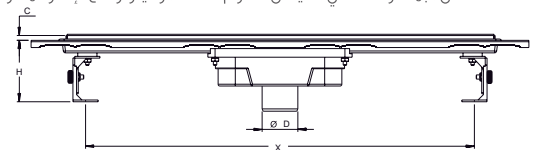
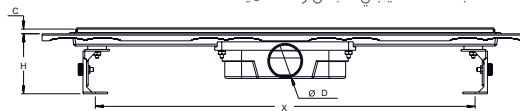
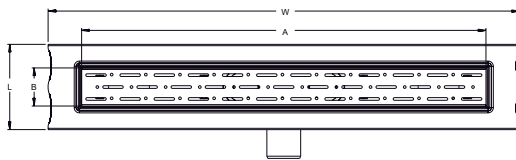

Code	W	L	H	Ø D	A	B	C	X	E
4043.TY050K.040.1	423	134	85	49.5	330	54	8	385	1.5
	492	134	85	49.5	400	54	8	456	1.5
	592	134	85	49.5	500	54	8	556	1.5
4043.TY050K.060.1	693	134	85	49.5	600	54	8	656	1.5
	893	134	85	49.5	800	54	8	856	1.5

Code	W	L	H	Ø D	A	B	C	X	E
4043.TA050K.040.1	423	134	100	49.5	330	54	8	385	1.5
	492	134	100	49.5	400	54	8	456	1.5
	592	134	100	49.5	500	54	8	556	1.5
4043.TA050K.060.1	693	134	100	49.5	600	54	8	656	1.5
	893	134	100	49.5	800	54	8	856	1.5

Table measure "mm"



# ELIT SERIES

# h10

## LEGAL 360°



Code	Outlet	Length		Price \$
------	--------	--------	--	----------

4043.00360K.033.1	Ø 50	33 cm	12	42,40
4043.00360K.040.1	Ø 50	40 cm	12	46,33
4043.00360K.050.1	Ø 50	50 cm	12	56,58
4043.00360K.060.1	Ø 50	60 cm	12	58,17
4043.00360K.080.1	Ø 50	80 cm	12	68,52

\* Shower drain / Ø 50 side outlet / Stainless body / Adjustable height stainless frame / Odor blocking by water  
 \* Душ канал / Ø 50 боковой выход / Корпус Из Нержавеющей С регулировкой высоты / Нержавеющая щетка / Гидрозатвор  
 قناة دش / مصرف جانبي / هيكل بلاستيكي / وعيار ارتفاع الإطار المقاوم للصدأ / حابس رائحة المياه

## LEGAL Y360°

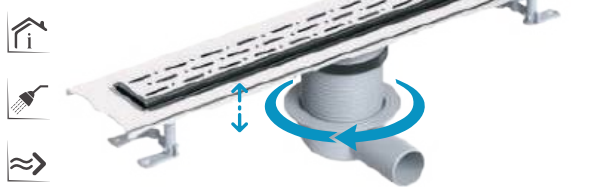

Code	Outlet	Length		Price \$
------	--------	--------	--	----------

4043.0Y360K.033.1	Ø 50	33 cm	12	46,40
4043.0Y360K.040.1	Ø 50	40 cm	12	50,33
4043.0Y360K.050.1	Ø 50	50 cm	12	60,58
4043.0Y360K.060.1	Ø 50	60 cm	12	62,17
4043.0Y360K.080.1	Ø 50	80 cm	12	72,52

\* Shower drain / Ø 50 side outlet / Stainless body / Adjustable height stainless frame / Odor blocking by water  
 \* Душ канал / Ø 50 боковой выход / Корпус Из Нержавеющей С регулировкой высоты / Нержавеющая щетка / Гидрозатвор  
 قناة دش / مصرف جانبي / هيكل بلاستيكي / وعيار ارتفاع الإطار المقاوم للصدأ / حابس رائحة المياه

## LEGAL 360° GOLD



Code	Outlet	Length		Price \$
------	--------	--------	--	----------

4043.00360G.033.1	Ø 50	20 cm	12	46,08
4043.00360G.040.1	Ø 50	33 cm	12	49,50
4043.00360G.050.1	Ø 50	40 cm	12	56,03
4043.00360G.060.1	Ø 50	50 cm	12	62,95
4043.00360G.080.1	Ø 50	60 cm	12	74,75

\* Shower drain / Ø 50 side outlet / Stainless body / Adjustable height stainless frame / Odor blocking by water  
 \* Душ канал / Ø 50 боковой выход / Корпус Из Нержавеющей С регулировкой высоты / Нержавеющая щетка / Гидрозатвор  
 قناة دش / مصرف جانبي / هيكل بلاستيكي / وعيار ارتفاع الإطار المقاوم للصدأ / حابس رائحة المياه

## LEGAL Y360° GOLD



Code	Outlet	Length		Price \$
------	--------	--------	--	----------

4043.0Y360G.033.1	Ø 50	33 cm	12	49,08
4043.0Y360G.040.1	Ø 50	40 cm	12	53,50
4043.0Y360G.050.1	Ø 50	50 cm	12	60,03
4043.0Y360G.060.1	Ø 50	60 cm	12	66,95
4043.0Y360G.080.1	Ø 50	80 cm	12	78,73

\* Shower drain / Ø 50 side outlet / Stainless body / Adjustable height stainless frame / Odor blocking by water  
 \* Душ канал / Ø 50 боковой выход / Корпус Из Нержавеющей С регулировкой высоты / Нержавеющая щетка / Гидрозатвор  
 قناة دش / مصرف جانبي / هيكل بلاستيكي / وعيار ارتفاع الإطار المقاوم للصدأ / حابس رائحة المياه



RAIN

SQUARE

FISH

BAHN

MARYLAND

SOLID



PART NO	PART DESCRIPTION	MATERIAL	PCS
	Ss Body	AISI 304	1
4043.2	Connection Part	PP	1
	Plastic Outlet	PP - EPDM	1
4043.4	Height Adjustable Legs	PP	2
	Height Adjustable Frame	AISI 304	1
4043.6	Odor blocking	ABS	1
	Stainless grid	AISI 304	1

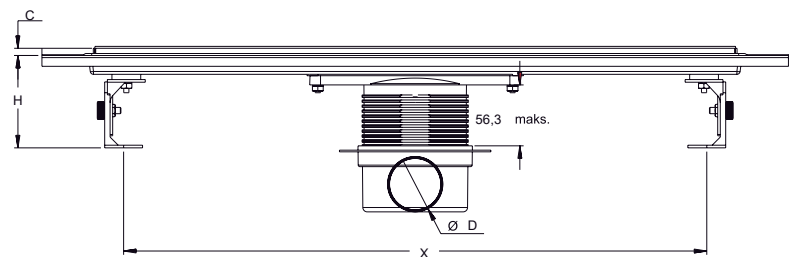
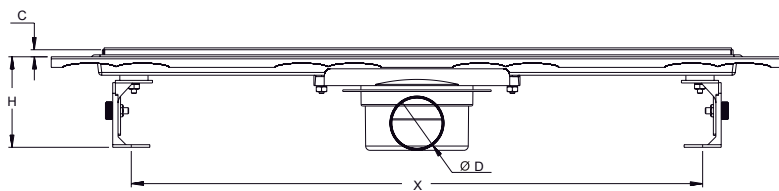
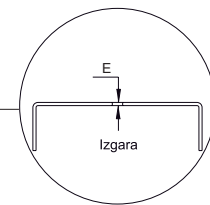
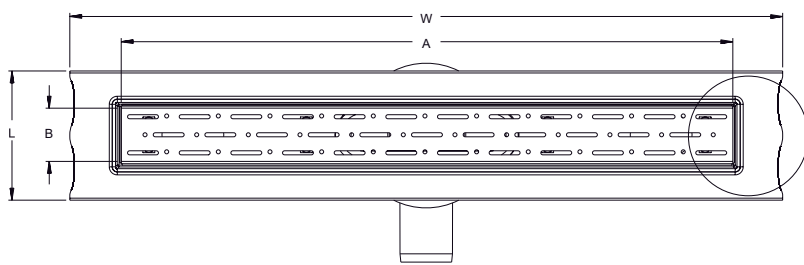
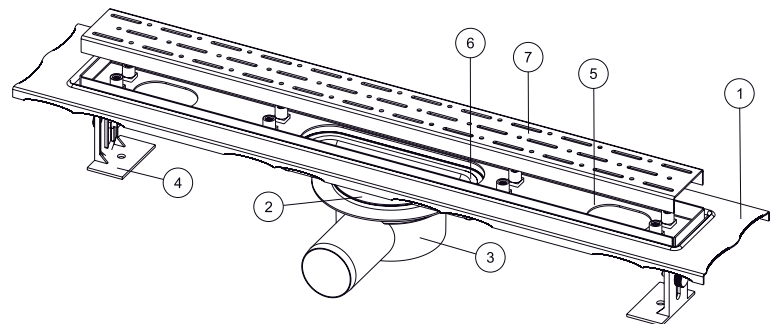

Code	W	L	H	Ø D	A	B	C	X	E
	423	134	85	49.5	330	54	8	385	1.5
4043.00360K.040.1	492	134	85	49.5	400	54	8	456	1.5
	592	134	85	49.5	500	54	8	556	1.5
4043.00360K.060.1	693	134	85	49.5	600	54	8	656	1.5
	893	134	85	49.5	800	54	8	856	1.5

Code	W	L	H	Ø D	A	B	C	X	E
	423	134	151	49.5	330	54	8	385	1.5
4043.0Y360K.040.1	492	134	151	49.5	400	54	8	456	1.5
	592	134	151	49.5	500	54	8	556	1.5
4043.0Y360K.060.1	693	134	151	49.5	600	54	8	656	1.5
	893	134	151	49.5	800	54	8	856	1.5

Table measure "mm"

# ELIT SERIES

# h10

## PREMIUM



Code      Outlet      Length           Price \$

4045.0Y050K.033.9	Ø 50	33 cm	12	66,77
4045.0Y050K.045.9	Ø 50	45 cm	12	78,28
4045.0Y050K.060.9	Ø 50	60 cm	12	98,52
4045.0Y050K.080.9	Ø 50	80 cm	12	70,28

\* Shower drain / Ø 50 side outlet / Stainless body / Adjustable Height 4 mm Stainless frame / Odor blocking by water

\* Душ канал / Ø 50 боковой выход / Корпус Из Нержавеющей / С регулировкой высоты 4 mm полное покрытие из нержавеющей / Гидрозатвор

قناة دش / مصرف جانبي / هيكل مقاوم للصدأ / ارتفاع قابل للتعديل 4 مم شبكة مقاوم للصدأ / حابس رائحة المياه

4045.0A050K.033.9	Ø 50	33 cm	12	66,77
4045.0A050K.045.9	Ø 50	45 cm	12	78,28
4045.0A050K.060.9	Ø 50	60 cm	12	98,52
4045.0A050K.080.9	Ø 50	80 cm	12	70,28

\* Shower drain / Ø 50 vertical outlet / Stainless body / Adjustable height stainless frame / Odor blocking by water

\* Душ канал / Ø 50 Нижний выход / Корпус Из Нержавеющей / С регулировкой высоты 4 mm полное покрытие из нержавеющей / Гидрозатвор

قناة دش / بمصرف سفلي / هيكل مقاوم للصدأ / ارتفاع قابل للتعديل 4 مم شبكة مقاوم للصدأ / حابس رائحة المياه

## PREMIUM 360°

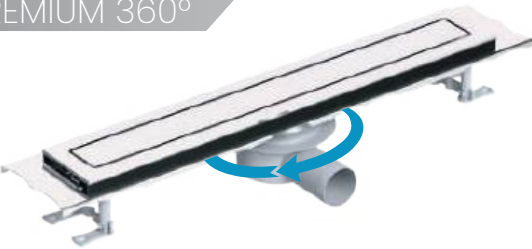

Code      Outlet      Length           Price \$

4045.00360K.033.9	Ø 50	33 cm	12	71,47
4045.00360K.045.9	Ø 50	45 cm	12	82,98
4045.00360K.060.9	Ø 50	60 cm	12	103,20
4045.00360K.080.9	Ø 50	80 cm	12	130,53

\* Shower drain / Ø 50 side outlet / Stainless body / Adjustable Height 4 mm Stainless frame / Odor blocking by water

\* Душ канал / Ø 50 боковой выход / Корпус Из Нержавеющей / С регулировкой высоты 4 mm полное покрытие из нержавеющей / Гидрозатвор

قناة دش / مصرف جانبي / هيكل مقاوم للصدأ / ارتفاع قابل للتعديل 4 مم شبكة مقاوم للصدأ / حابس رائحة المياه

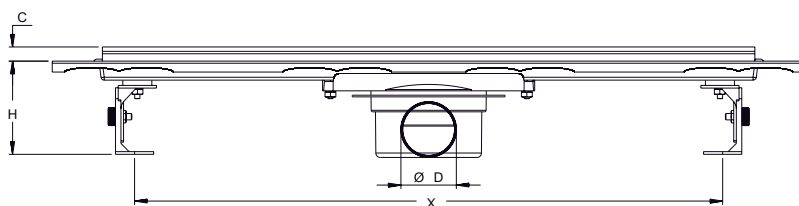
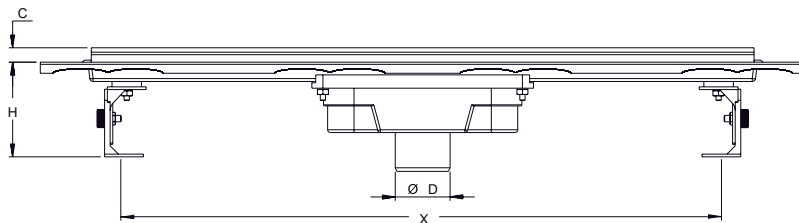
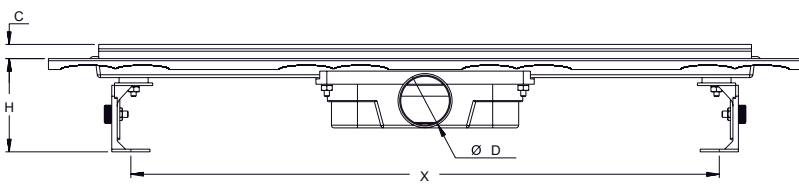
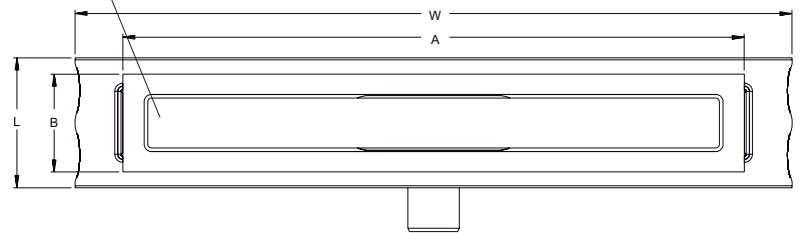
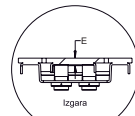

Code	W	L	H	Ø D	A	B	C	X	E
423	134	85	49.5	330	94	13	385	4	
4045.0Y050K.045.9	492	134	85	49.5	400	94	13	456	4
693	134	85	49.5	600	94	13	656	4	
4045.0Y050K.080.9	893	134	85	49.5	800	94	13	856	4
Code	W	L	H	Ø D	A	B	C	X	E
423	134	100	49.5	330	94	13	385	4	
4045.0A050K.045.9	492	134	100	49.5	400	94	13	456	4
693	134	100	49.5	600	94	13	656	4	
4045.0A050K.080.9	893	134	100	49.5	800	94	13	856	4
Code	W	L	H	Ø D	A	B	C	X	E
423	134	85	49.5	330	94	13	385	4	
4045.00360K.045.9	492	134	85	49.5	450	94	13	456	4
693	134	85	49.5	600	94	13	656	4	
4045.00360K.080.9	893	134	85	49.5	800	94	13	856	4

Table measure \*mm\*

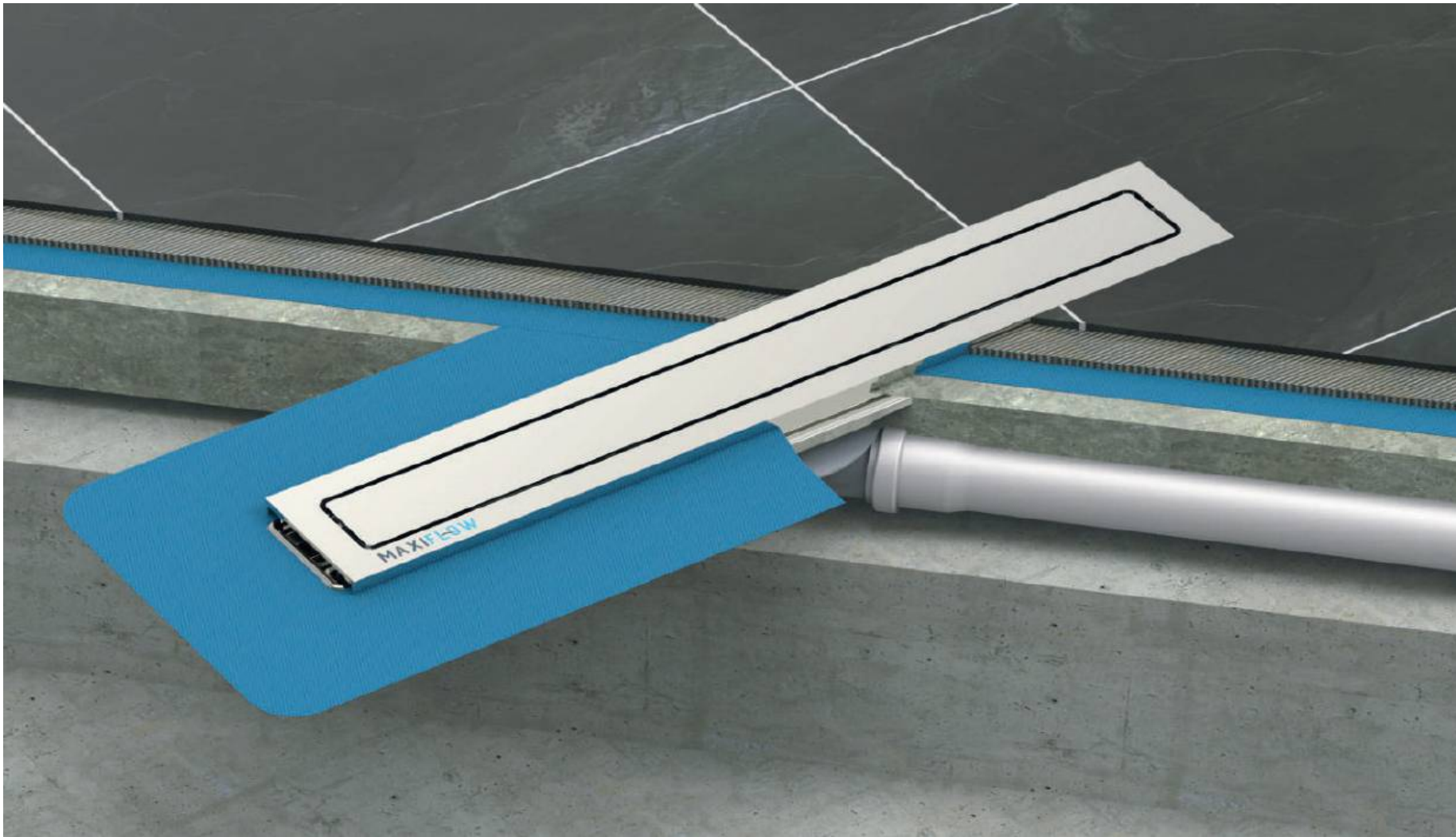

DN 50 side and vertical outlet - compatible with PVC pipe connections, blocking odor by water (36mm). The flow rate is 32 liters/min. Resistant against external chemical effects, operating temperature is between -30°C and +75°C. The grid is made of 304 grade stainless steel.

With its 304 grade stainless steel grid, it has a quality and stylish-looking. It can be easily applied at floor. With its odor blocking by water support, it prevents the bad smell coming from the installation. With its adjustable height legs, it can be adjusted depending on the screed concrete. High resistance against the organic and inorganic chemicals, resistant against most acidic and vertically aqueous oxidation.

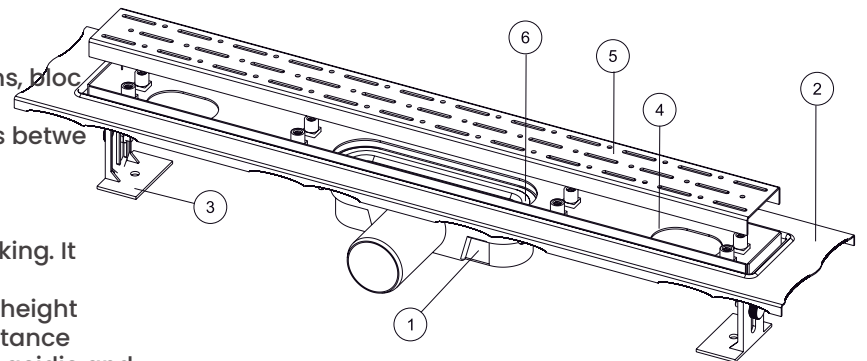

Common use of bathroom shower, hospital and hotel shower areas, locker-room shower areas etc.

Grid patterns can be chosen in gold, bronze or other optional colors in accordance with your desire.

It is not recommended to use high-density cleaners for a long-time.

PART NO	PART DESCRIPTION	MATERIAL	PCS
	Plastic Body	ABS	1
4043.2	SS Body	AISI 304	1
	Height Adjustable Legs	PP	2
4043.4	Height Adjustable Frame	AISI 304	1
	Stainless grid	AISI 304	1
4043.6	Odor blocking	ABS	1



# MAXI SERIES

# h10

## PREMIUM



Code      Outlet      Length           Price \$

4055.0Y050K.033.9	Ø 50	33 cm	12	86,45
4055.0Y050K.045.9	Ø 50	45 cm	12	97,12
4055.0Y050K.060.9	Ø 50	60 cm	12	123,30
4055.0Y050K.080.9	Ø 50	80 cm	12	157,57

\* Shower drain / Ø 50 side outlet / Stainless body / Adjustable height stainless frame / Odor blocking by water  
 \* Душ канал / Ø 50 боковой выход / Корпус Из Нержавеющей С регулировкой высоты / Нержавеющая щетка / Гидрозатвор  
 قنّاة دش / مصرف جانبي / هيكل مقاوم للصدأ / ارتفاع الإطار المقاوم للصدأ / حابس رائحة المياه

## PREMIUM



Code      Outlet      Length           Price \$

4055.0Y050K.033.9	Ø 50	33 cm	12	86,45
4055.0Y050K.045.9	Ø 50	45 cm	12	97,12
4055.0Y050K.060.9	Ø 50	60 cm	12	123,30
4055.0Y050K.080.9	Ø 50	80 cm	12	157,57

\* Shower drain / Ø 50 vertical outlet / Stainless body Adjustable height stainless frame / Odor blocking by water  
 \* Душ канал / Ø 50 Нижний выход / Корпус Из Нержавеющей С регулировкой высоты / Нержавеющая щетка / Гидрозатвор  
 قنّاة دش / مصرف سفلي / هيكل مقاوم للصدأ / ارتفاع الإطار المقاوم للصدأ / حابس رائحة المياه

## PREMIUM

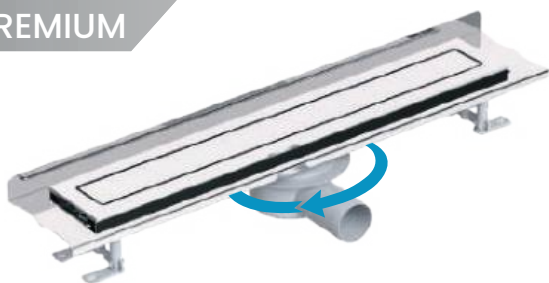

Code      Outlet      Length           Price \$

4055.00360K.033.9	Ø 50	33 cm	12	80,92
4055.00360K.045.9	Ø 50	45 cm	12	94,85
4055.00360K.060.9	Ø 50	60 cm	12	120,62
4055.00360K.080.9	Ø 50	80 cm	12	153,95

\* Shower drain / Ø 50 side outlet / Stainless body / Adjustable height stainless frame / Odor blocking by water  
 \* Душ канал / Ø 50 боковой выход / Корпус Из Нержавеющей С регулировкой высоты / Нержавеющая щетка / Гидрозатвор  
 قنّاة دش / مصرف جانبي / هيكل مقاوم للصدأ / ارتفاع الإطار المقاوم للصدأ / حابس رائحة المياه

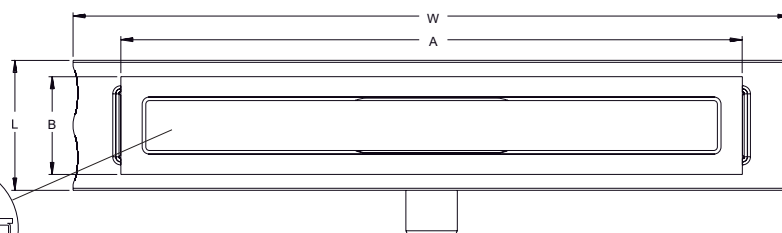
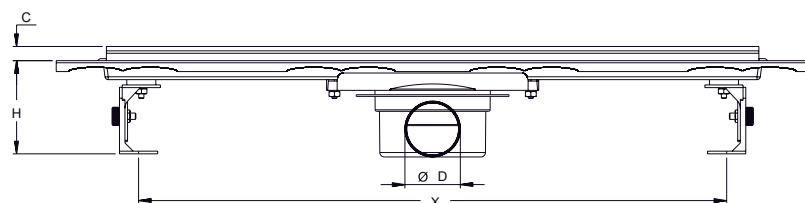
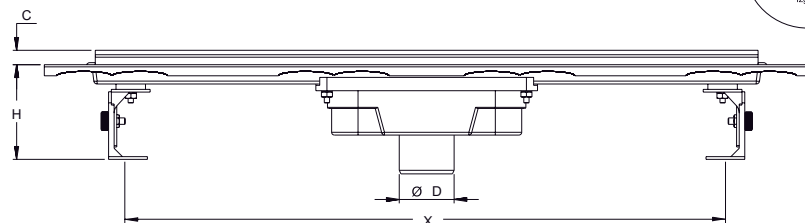
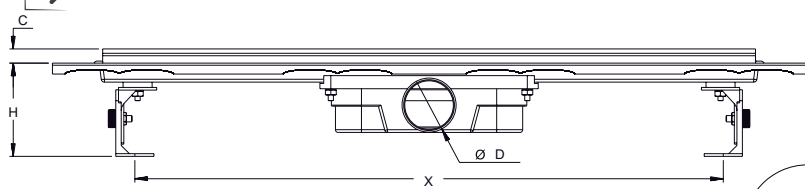

Code	W	L	H	Ø D	A	B	C	X	E
4045.0Y050K.045.9	423	134	85	49.5	330	94	13	385	4
4045.0Y050K.080.9	492	134	85	49.5	400	94	13	456	4
4045.0Y050K.080.9	693	134	85	49.5	600	94	13	656	4
4045.0Y050K.080.9	893	134	85	49.5	800	94	13	856	4
Code	W	L	H	Ø D	A	B	C	X	E
4045.0A050K.045.9	423	134	100	49.5	330	94	13	385	4
4045.0A050K.080.9	492	134	100	49.5	400	94	13	456	4
4045.0A050K.080.9	693	134	100	49.5	600	94	13	656	4
4045.0A050K.080.9	893	134	100	49.5	800	94	13	856	4
Code	W	L	H	Ø D	A	B	C	X	E
4045.00360K.045.9	423	134	85	49.5	330	94	13	385	4
4045.00360K.080.9	492	134	85	49.5	450	94	13	456	4
4045.00360K.080.9	693	134	85	49.5	600	94	13	656	4
4045.00360K.080.9	893	134	85	49.5	800	94	13	856	4

Table measure "mm"

# MAXI SERIES

# h10

## LEGAL



Code

Outlet

Length



Price \$

4053.0Y050K.033.1	Ø 50	33 cm	12	42,02
4053.0Y050K.040.1	Ø 50	40 cm	12	46,13
4053.0Y050K.050.1	Ø 50	50 cm	12	52,23
4053.0Y050K.060.1	Ø 50	60 cm	12	58,73
4053.0Y050K.080.1	Ø 50	80 cm	12	70,38

\* Shower drain / Ø 50 side outlet / Stainless body / Adjustable height stainless frame / Odor blocking by water  
\* Душ канал / Ø 50 боковой выход / Корпус Из Нержавеющей С регулировкой высоты / Нержавеющая щетка / Гидрозатвор

قناة دش / مصرف جانبي/ هيكل مقاوم للصدأ / ارتفاع الإطار المقاوم للصدأ / حابس رائحة المياه

4053.0A050K.033.1	Ø 50	33 cm	12	42,02
4053.0A050K.040.1	Ø 50	40 cm	12	46,13
4053.0A050K.050.1	Ø 50	50 cm	12	52,23
4053.0A050K.060.1	Ø 50	60 cm	12	58,73
4053.0A050K.080.1	Ø 50	80 cm	12	70,38

\* Shower drain / Ø 50 vertical outlet / Stainless body Adjustable height stainless frame / Odor blocking by water  
\* Душ канал / Ø 50 Нижний выход / Корпус Из Нержавеющей С регулировкой высоты / Нержавеющая щетка / Гидрозатвор

قناة دش / بمصرف سفلي/ هيكل مقاوم للصدأ / ارتفاع الإطار المقاوم للصدأ / حابس رائحة المياه

## LEGAL 360°



Code

Outlet

Length



Price \$

4053.00360K.033.1	Ø 50	33 cm	12	43,65
4053.00360K.040.1	Ø 50	40 cm	12	47,78
4053.00360K.050.1	Ø 50	50 cm	12	53,87
4053.00360K.060.1	Ø 50	60 cm	12	60,37
4053.00360K.080.1	Ø 50	80 cm	12	72,02

\* Shower drain / Ø 50 side outlet / Stainless body / Adjustable height stainless frame / Odor blocking by water  
\* Душ канал / Ø 50 боковой выход / Корпус Из Нержавеющей С регулировкой высоты / Нержавеющая щетка / Гидрозатвор

قناة دش / مصرف جانبي/ هيكل مقاوم للصدأ / ارتفاع الإطار المقاوم للصدأ / حابس رائحة المياه

## LEGAL Y360°

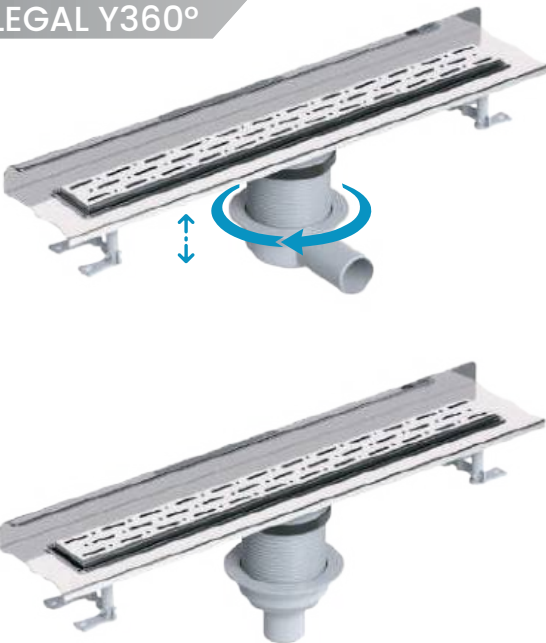

Code

Outlet

Length



Price \$

4053.0Y360K.033.1	Ø 50	33 cm	12	47,65
4053.0Y360K.040.1	Ø 50	40 cm	12	51,77
4053.0Y360K.050.1	Ø 50	50 cm	12	57,85
4053.0Y360K.060.1	Ø 50	60 cm	12	64,37
4053.0Y360K.080.1	Ø 50	80 cm	12	76,02

\* Shower drain / Ø 50 side outlet / Stainless body / Adjustable height stainless frame / Odor blocking by water  
\* Душ канал / Ø 50 боковой выход / Корпус Из Нержавеющей С регулировкой высоты / Нержавеющая щетка / Гидрозатвор

قناة دش / مصرف جانبي/ هيكل مقاوم للصدأ / ارتفاع الإطار المقاوم للصدأ / حابس رائحة المياه

4053.0A360K.033.1	Ø 50	33 cm	12	47,65
4053.0A360K.040.1	Ø 50	40 cm	12	51,77
4053.0A360K.050.1	Ø 50	50 cm	12	57,85
4053.0A050K.060.1	Ø 50	60 cm	12	64,37
4053.0A050K.080.1	Ø 50	80 cm	12	76,02

\* Shower drain / Ø 50 vertical outlet / Stainless body Adjustable height stainless frame / Odor blocking by water  
\* Душ канал / Ø 50 Нижний выход / Корпус Из Нержавеющей С регулировкой высоты / Нержавеющая щетка / Гидрозатвор

قناة دش / بمصرف سفلي/ هيكل مقاوم للصدأ / ارتفاع الإطار المقاوم للصدأ / حابس رائحة المياه

# TRIANGLE SERIES

h10

## LINE



Code

Outlet

Length



Price \$

4062.0Y050K.033.0

Ø 50

33 cm

12

13,75

\*Triangle Shower drain / Ø 50 side outlet / Plastic body Stainless grid / Odor blocking by water

\*Треугольник Душ канал / Ø 50 боковой выход / пластичное тело / Нержавеющая щетка Гидрозатвор

4062.0A050K.033.0

Ø 50

33 cm

12

13,75

\*Triangle Shower drain / Ø 50 vertical outlet / Plastic body Stainless grid / Odor blocking by water

\*Треугольник Душ канал / Ø 50 Нижний выход / пластичное тело / Нержавеющая щетка / Гидрозатвор

## LINE GOLD



Code

Outlet

Length



Price \$

4062.0Y050G.033.0

Ø 50

33 cm

12

17,05

\*Triangle Shower drain / Ø 50 side outlet / Plastic body Stainless grid / Odor blocking by water

\*Треугольник Душ канал / Ø 50 боковой выход / пластичное тело / Нержавеющая щетка Гидрозатвор

4062.0A050G.033.0

Ø 50

33 cm

12

17,05

\*Triangle Shower drain / Ø 50 vertical outlet / Plastic body Stainless grid / Odor blocking by water

\*Треугольник Душ канал / Ø 50 Нижний выход / пластичное тело / Нержавеющая щетка / Гидрозатвор

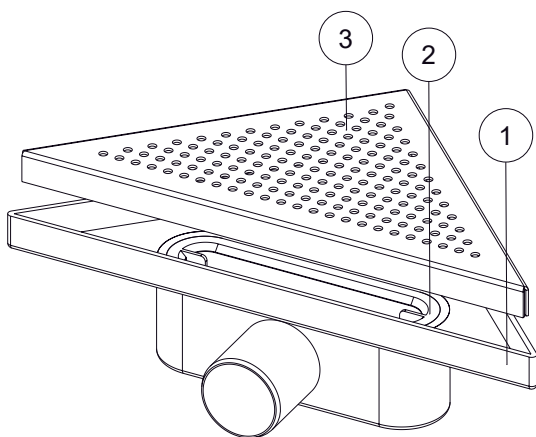

DN 50 side and vertical outlet - compatible with PVC pipe connections, blocking odor by water (36mm). The flow rate is 32 liters/min.

Resistant against external chemical effects, operating temperature is between -30°C and +75°C. The grid is made of 304 grade stainless steel.

With its 304 grade stainless steel grid, it has a quality and stylish-looking. It can be easily applied at floor. With its odor blocking by water support, it prevents the bad smell coming from the installation. With its adjustable height legs, it can be adjusted depending on the screed concrete. High resistance against the organic and inorganic chemicals, resistant against most acidic and vertically aqueous oxidation.

Common use of bathroom shower, hospital and hotel shower areas, locker-room shower areas etc.

Grid patterns can be chosen in gold, bronze or other optional colors in accordance with your desire.

It is not recommended to use high-density cleaners for a long-time.

PART NO	PART DESCRIPTION	MATERIAL	PCS
	Plastic Body	ABS	1
4062.2	Odor blocking	ABS	1
	Stainless grid	AISI 304	1



SOLID

PASIC

# TRIANGLE SERIES

h10

## LEGAL



Code      Outlet      Length           Price \$

4063.0Y050K.033.0	Ø 50	33 cm	12	22,45
-------------------	------	-------	----	-------

\*Triangle Shower drain / Ø 50 side outlet / Stainless body / Stainless grid / Odor blocking by water  
\*Треугольник Душ канал / Ø 50 боковой выход / Корпус Из Нержавеющей / Нержавеющая щетка / Гидрозатвор

هیکل مقاوم للصدأ / شبكة مقاومة للصدأ / حابس رائحة المياه / قنّاء دش مثلث / مصرف جانبي

4063.0A050K.033.0	Ø 50	33 cm	12	22,45
-------------------	------	-------	----	-------

\*Triangle Shower drain Ø 50 vertical outlet / Stainless body / Stainless grid / Odor blocking by water  
\*Треугольник Душ канал / Ø 50 Нижний выход / Корпус Из Нержавеющей / Нержавеющая щетка / Гидрозатвор

قنّاء دش مثلث / بمصرف سفلي / هیکل مقاوم للصدأ / شبكة مقاومة للصدأ / حابس رائحة المياه

## LEGAL GOLD

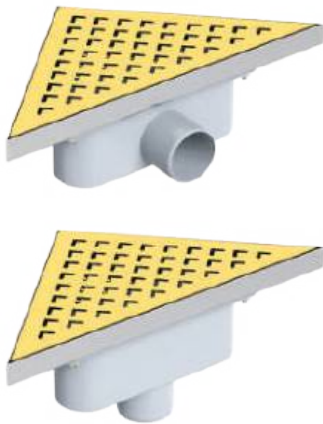

Code      Outlet      Length           Price \$

4063.0Y050G.033.0	Ø 50	33 cm	12	25,75
-------------------	------	-------	----	-------

\*Triangle Shower drain / Ø 50 side outlet / Stainless body / Stainless grid / Odor blocking by water  
\*Треугольник Душ канал / Ø 50 боковой выход / Корпус Из Нержавеющей / Нержавеющая щетка / Гидрозатвор

هیکل مقاوم للصدأ / شبكة مقاومة للصدأ / حابس رائحة المياه / قنّاء دش مثلث / مصرف جانبي

4063.0A050G.033.0	Ø 50	33 cm	12	25,75
-------------------	------	-------	----	-------

\*Triangle Shower drain Ø 50 vertical outlet / Stainless body / Stainless grid / Odor blocking by water  
\*Треугольник Душ канал / Ø 50 Нижний выход / Корпус Из Нержавеющей / Нержавеющая щетка / Гидрозатвор

قنّاء دش مثلث / بمصرف سفلي / هیکل مقاوم للصدأ / شبكة مقاومة للصدأ / حابس رائحة المياه

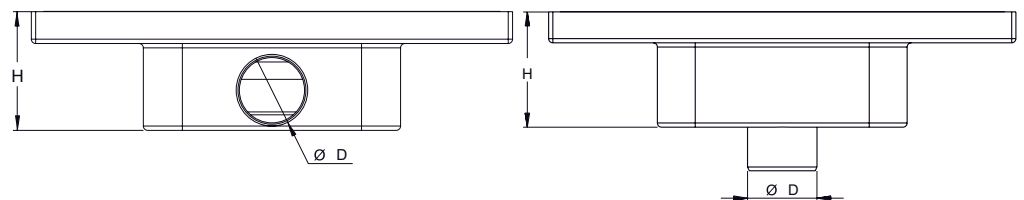
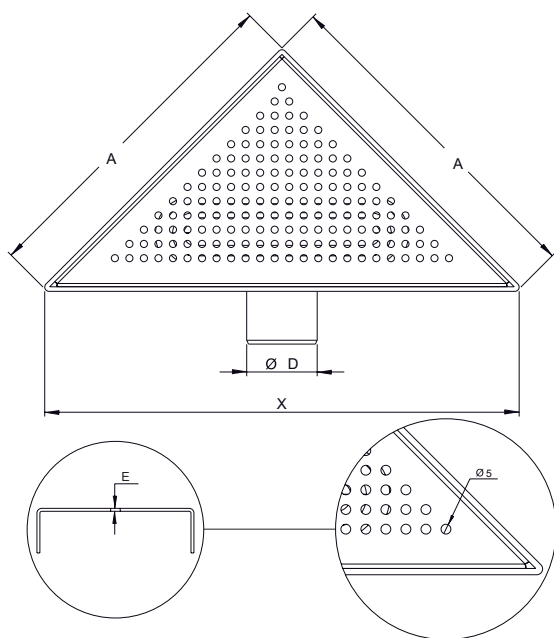

Code	H	Ø D	A	X	E
	84	49.5	234	330	1.5

Code	H	Ø D	A	X	E
	84	49.5	234	330	1.5

Table measure "mm"





SOLID

PASIFIC

# TRIANGLE SERIES

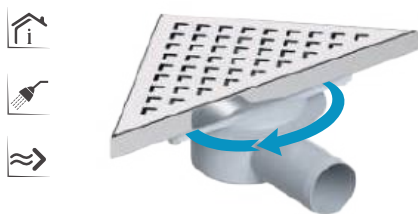
## LEGAL 360°





Code	Outlet	Length		Price \$
4063.00360K.033.0	Ø 50	33 cm	12	24,03

\*Triangle Shower drain / Ø 50 side outlet / Stainless body / Stainless grid / Odor blocking by water  
 \*Треугольник Душ канал / Ø 50 боковой выход / Корпус Из Нержавеющей / Нержавеющая щетка / Гидрозатвор

قناة دش مثلث / مصرف جانبي / هيكل مقاوم للصدأ / شبكة مقاومة للصدأ / حابس رائحة المياه

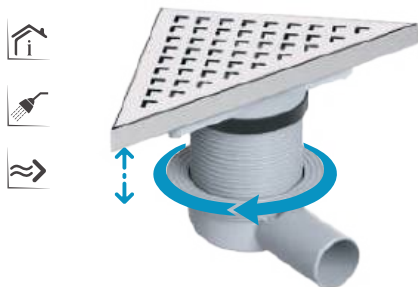
## LEGAL Y360°





Code	Outlet	Length		Price \$
4063.0Y360K.033.0	Ø 50	33 cm	12	27,50

\*Triangle Shower drain / Ø 50 side outlet / Stainless body / Stainless grid / Odor blocking by water  
 \*Треугольник Душ канал / Ø 50 боковой выход / Корпус Из Нержавеющей / Нержавеющая щетка / Гидрозатвор

قناة دش مثلث / مصرف جانبي / هيكل مقاوم للصدأ / شبكة مقاومة للصدأ / حابس رائحة المياه

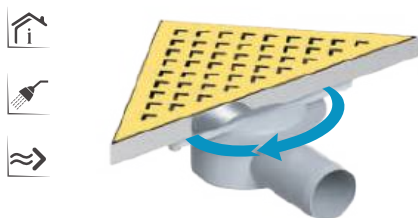
## LEGAL 360° GOLD





Code	Outlet	Length		Price \$
4063.00360G.033.0	Ø 50	33 cm	12	27,32

\*Triangle Shower drain / Ø 50 side outlet / Stainless body / Stainless grid / Odor blocking by water  
 \*Треугольник Душ канал / Ø 50 боковой выход / Корпус Из Нержавеющей / Нержавеющая щетка / Гидрозатвор

قناة دش مثلث / مصرف جانبي / هيكل مقاوم للصدأ / شبكة مقاومة للصدأ / حابس رائحة المياه

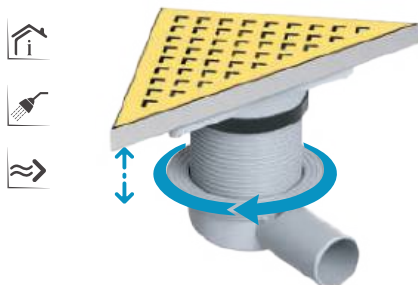
## LEGAL Y360° GOLD



Code	Outlet	Length		Price \$
4063.0Y360G.033.0	Ø 50	33 cm	12	30,78

\*Triangle Shower drain / Ø 50 side outlet / Stainless body / Stainless grid / Odor blocking by water  
 \*Треугольник Душ канал / Ø 50 боковой выход / Корпус Из Нержавеющей / Нержавеющая щетка / Гидрозатвор

قناة دش مثلث / مصرف جانبي / هيكل مقاوم للصدأ / شبكة مقاومة للصدأ / حابس رائحة المياه



SOLID

PASIFIC

# TRIANGLE SERIES



DN 50 side and vertical outlet - compatible with PVC pipe connections, blocking odor by water (36mm). The flow rate is 32 liters/min. Resistant against external chemical effects, operating temperature is between -30°C and +75°C. The grid is made of 304 grade stainless steel.

With its 304 grade stainless steel grid, it has a quality and stylish-looking. It can be easily applied at floor. With its odor blocking by water support, it prevents the bad smell coming from the installation. With its adjustable height legs, it can be adjusted depending on the screed concrete. High resistance against the organic and inorganic chemicals, resistant against most acidic and vertically aqueous oxidation.

Common use of bathroom shower, hospital and hotel shower areas, locker-room shower areas etc.

Grid patterns can be chosen in gold, bronze or other optional colors in accordance with your desire.

It is not recommended to use high-density cleaners for a long-time.

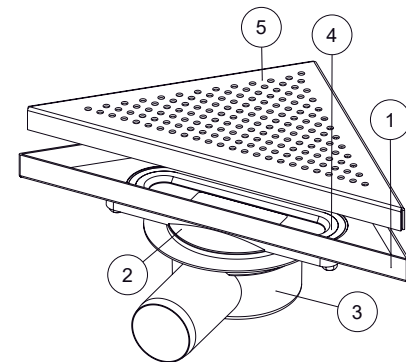

PART NO	PART DESCRIPTION	MATERIAL	PCS
	SS Body	AISI 304	1
4063.2	Connection	PP	1
	Plastic Body	PP - EPDM	1
4063.4	Odor blocking	ABS	1
	Stainless grid	AISI 304	1

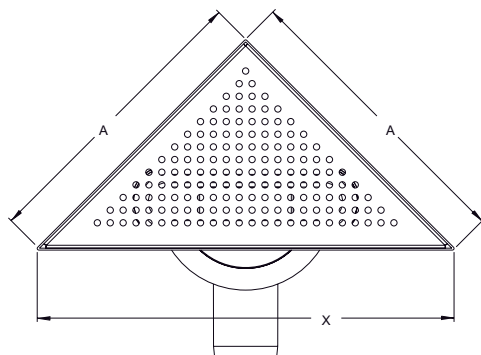

Code	H	Ø D	A	X	E
	91	49.5	234	330	1.5

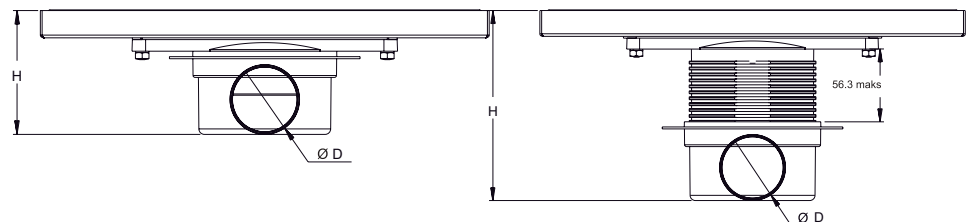
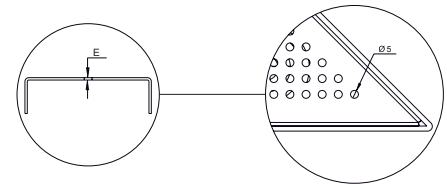

Code	H	Ø D	A	X	E
	147	49.5	234	330	1.5

Table measure "mm"

# SQUARE SERIES

h10

## LINE

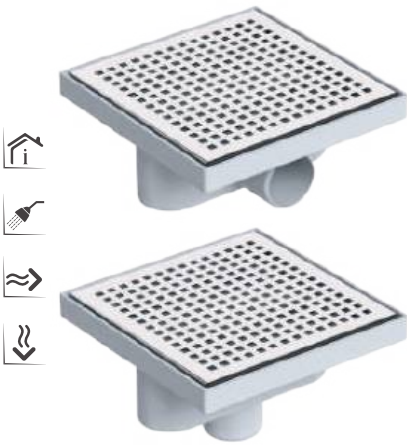

## LINE GOLD

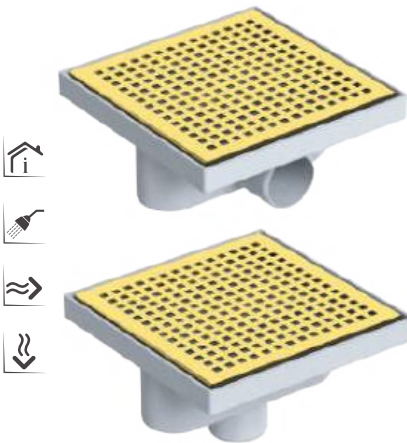

Code

Outlet

Length



Price \$

4072.0Y050K.020.0

Ø 50

20x20 cm

12

17,12

\*Square Shower drain / Ø 50 side outlet / Plastic body/ Stainless grid / Odor blocking by water  
\*Квадратный Душ канал / Ø 50 боковой выход / пластиковое тело / Нержавеющая щетка / Гидрозатвор  
قناة دش مربع / مصرف جانبي / هيكل بلاستيكي / شبكة مقاومة للصدأ / حابس رائحة المياه

4072.0A050K.020.0

Ø 50

20x20 cm

12

17,12

\*Square Shower drain / Ø 50 vertical outlet Plastic body Stainless grid / Odor blocking by water  
\*Квадратный Душ канал / Ø 50 Нижний выход / пластиковое тело / Нержавеющая щетка / Гидрозатвор  
قناة دش مربع / بمصرف سفلي / هيكل بلاستيكي / شبكة مقاومة للصدأ / حابس رائحة المياه

Code

Outlet

Length



Price \$

4072.0Y050G.020.0

Ø 50

20x20 cm

12

22,40

\*Square Shower drain / Ø 50 side outlet / Plastic body/ Stainless grid / Odor blocking by water  
\*Квадратный Душ канал / Ø 50 боковой выход / пластиковое тело / Нержавеющая щетка / Гидрозатвор  
قناة دش مربع / مصرف جانبي / هيكل بلاستيكي / شبكة مقاومة للصدأ / حابس رائحة المياه

4072.0A050G.020.0

Ø 50

20x20 cm

12

22,40

\*Square Shower drain / Ø 50 vertical outlet Plastic body Stainless grid / Odor blocking by water  
\*Квадратный Душ канал / Ø 50 Нижний выход / пластиковое тело / Нержавеющая щетка / Гидрозатвор  
قناة دش مربع / بمصرف سفلي / هيكل بلاستيكي / شبكة مقاومة للصدأ / حابس رائحة المياه

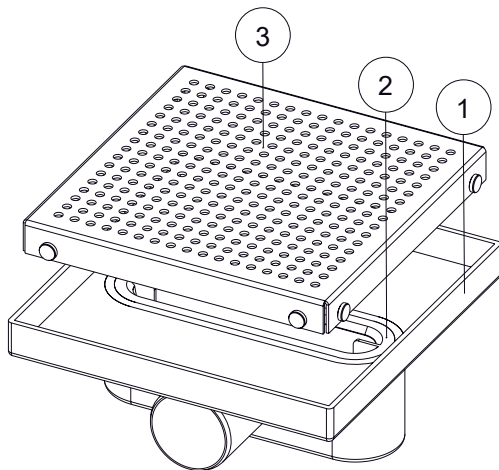

DN 50 side and vertical outlet - compatible with PVC pipe connections, blocking odor by water (36mm). The flow rate is 32 liters/min.

Resistant against external chemical effects, operating temperature is between -30°C and +75°C. The grid is made of 304 grade stainless steel.

With its 304 grade stainless steel grid, it has a quality and stylish-looking. It can be easily applied at floor. With its odor blocking by water support, it prevents the bad smell coming from the installation. With its adjustable height legs, it can be adjusted depending on the screed concrete. High resistance against the organic and inorganic chemicals, resistant against most acidic and vertically aqueous oxidation.

PART NO	PART DESCRIPTION	MATERIAL	PCS
	Plastic Body	ABS	1
4072.2	Odor blocking	ABS	1
	Stainless grid	AISI 304	1

Common use of bathroom shower, hospital and hotel shower areas, locker-room shower areas etc.

Grid patterns can be chosen in gold, bronze or other optional colors in accordance with your desire.

It is not recommended to use high-density cleaners for a long-time.



SOLID

SQUARE

# SQUARE SERIES

h10

## LEGAL

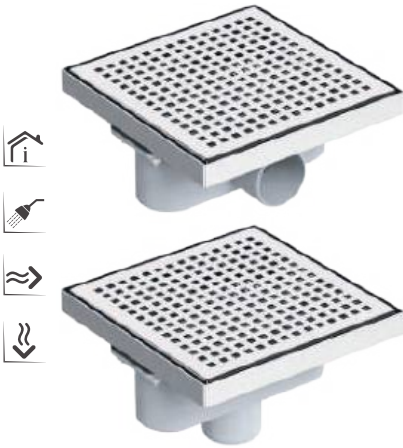

Code      Outlet      Length           Price \$

4073.0Y050K.020.0	Ø 50	20x20 cm	12	27,65
-------------------	------	----------	----	-------

\*Square Shower drain / Ø 50 side outlet / Stainless body / Stainless grid / Odor blocking by water  
 \*Квадратный Душ канал / Ø 50 боковой выход / Корпус Из Нержавеющей / Нержавеющая щетка / Гидрозатвор

قناة دش مربع / مصرف جانبي / هيكل مقاوم للصدأ / شبكة مقاومة للصدأ / حابس رائحة المياه

4073.0A050K.020.0	Ø 50	20x20 cm	12	27,65
-------------------	------	----------	----	-------

\*Square Shower drain / Ø 50 vertical outlet / Stainless body / Stainless grid / Odor blocking by water  
 \*Квадратный Душ канал / Ø 50 Нижний выход / Корпус Из Нержавеющей / Нержавеющая щетка / Гидрозатвор

قناة دش مربع / بمصرف سفلي / هيكل مقاوم للصدأ / شبكة مقاومة للصدأ / حابس رائحة المياه

## LEGAL GOLD

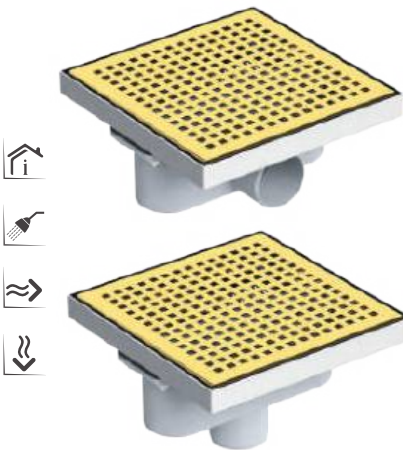

Code      Outlet      Length           Price \$

4073.0Y050G.020.0	Ø 50	20x20 cm	12	32,88
-------------------	------	----------	----	-------

\*Square Shower drain / Ø 50 side outlet / Stainless body / Stainless grid / Odor blocking by water  
 \*Квадратный Душ канал / Ø 50 боковой выход / Корпус Из Нержавеющей / Нержавеющая щетка / Гидрозатвор

قناة دش مربع / مصرف جانبي / هيكل مقاوم للصدأ / شبكة مقاومة للصدأ / حابس رائحة المياه

4073.0A050G.020.0	Ø 50	20x20 cm	12	32,88
-------------------	------	----------	----	-------

\*Square Shower drain / Ø 50 vertical outlet / Stainless body / Stainless grid / Odor blocking by water  
 \*Квадратный Душ канал / Ø 50 Нижний выход / Корпус Из Нержавеющей / Нержавеющая щетка / Гидрозатвор

قناة دش مربع / بمصرف سفلي / هيكل مقاوم للصدأ / شبكة مقاومة للصدأ / حابس رائحة المياه

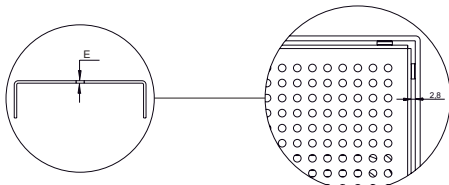
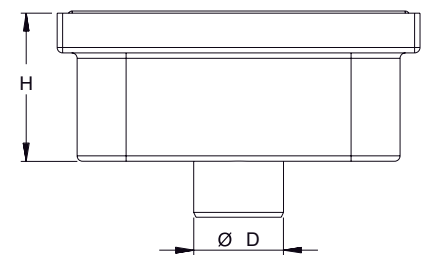
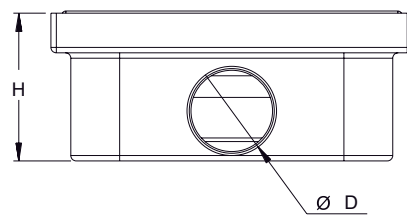
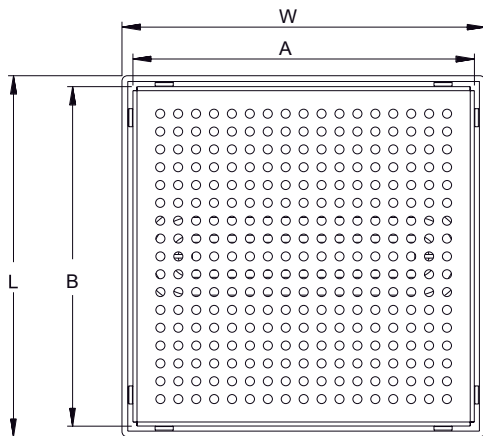

Code	W	L	H	Ø D	A	B	E
	200	200	82	49.5	188	188	1.5

Code	W	L	H	Ø D	A	B	E
	200	200	82	49.5	188	188	1.5

Table measure "mm"



SOLID

SQUARE



# SQUARE SERIES

h10

## LEGAL 360°

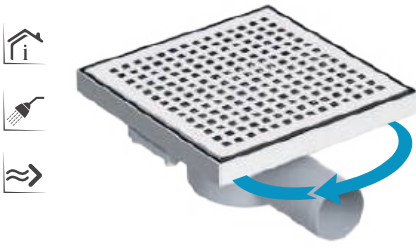

Code

Outlet

Length



Price \$

4073.00360K.020.0

Ø 50

20x20cm

12

28,43

\*Square Shower drain / Ø 50 side outlet / Stainless body Stainless grid / Odor blocking by water  
\*Квадратный Душ канал / Ø 50 боковой выход / Корпус Из Нержавеющей / Нержавеющая щетка / Гидрозатвор

قناة دش مربع / مصرف جانبي / هيكل مقاوم للصدأ / شبكة مقاومة للصدأ / حابس رائحة المياه

## LEGAL Y360°

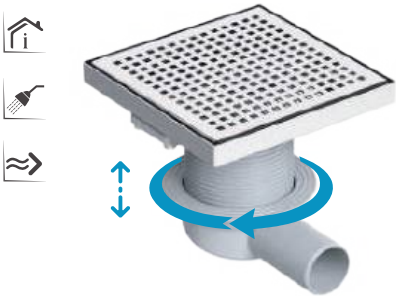

Code

Outlet

Length



Price \$

4073.0Y360K.020.0

Ø 50

20x20cm

12

31,90

\*Square Shower drain / Ø 50 side outlet / Stainless body Stainless grid / Odor blocking by water  
\*Квадратный Душ канал / Ø 50 боковой выход / Корпус Из Нержавеющей / Нержавеющая щетка / Гидрозатвор

قناة دش مربع / مصرف جانبي / هيكل مقاوم للصدأ / شبكة مقاومة للصدأ / حابس رائحة المياه

## LEGAL 360° GOLD

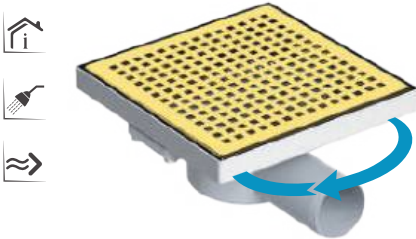

Code

Outlet

Length



Price \$

4073.00360G.020.0

Ø 50

20x20cm

12

33,67

\*Square Shower drain / Ø 50 side outlet / Stainless body Stainless grid / Odor blocking by water  
\*Квадратный Душ канал / Ø 50 боковой выход / Корпус Из Нержавеющей / Нержавеющая щетка / Гидрозатвор

قناة دش مربع / مصرف جانبي / هيكل مقاوم للصدأ / شبكة مقاومة للصدأ / حابس رائحة المياه

## LEGAL Y360° GOLD

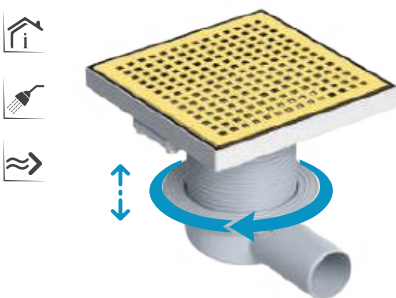

Code

Outlet

Length



Price \$

4073.0Y360G.020.0

Ø 50

20x20cm

12

37,13

\*Square Shower drain / Ø 50 side outlet / Stainless body Stainless grid / Odor blocking by water  
\*Квадратный Душ канал / Ø 50 боковой выход / Корпус Из Нержавеющей / Нержавеющая щетка / Гидрозатвор

قناة دش مربع / مصرف جانبي / هيكل مقاوم للصدأ / شبكة مقاومة للصدأ / حابس رائحة المياه



SOLID

SQUARE

# SQUARE SERIES

h10



DN 50 side and vertical outlet - compatible with PVC pipe connections, blocking odor by water (36mm). The flow rate is 32 liters/min. Resistant against external chemical effects, operating temperature is between -30°C and +75°C. The grid is made of 304 grade stainless steel.

With its 304 grade stainless steel grid, it has a quality and stylish-looking. It can be easily applied at floor. With its odor blocking by water support, it prevents the bad smell coming from the installation. With its adjustable height legs, it can be adjusted depending on the screed concrete. High resistance against the organic and inorganic chemicals, resistant against most acidic and vertically aqueous oxidation.

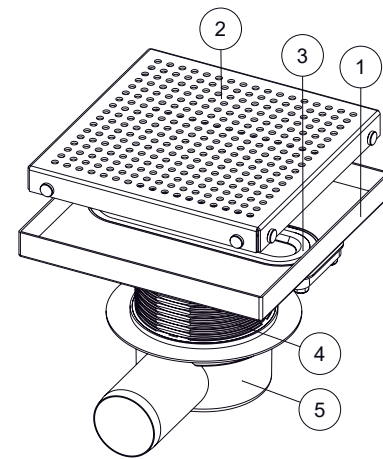

Common use of bathroom shower, hospital and hotel shower areas, locker room shower areas etc.

PART NO	PART DESCRIPTION	MATERIAL	PCS
	SS Body	AISI 304	1
4073.2	SS Grid	AISI 304	1
	Odor blocking	ABS	1
4073.4	Connection	PP	1
	Plastic Body	PP - EPDM	1

Grid patterns can be chosen in gold, bronze or other optional colors in accordance with your desire.

It is not recommended to use high-density cleaners for a long-time.

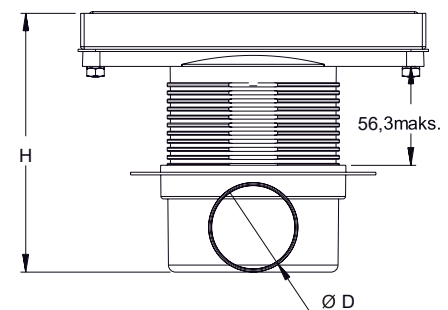
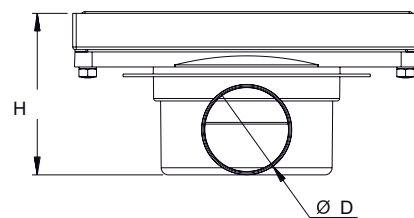
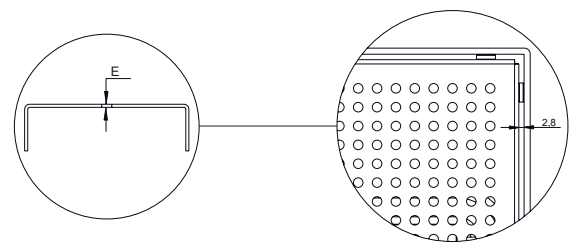
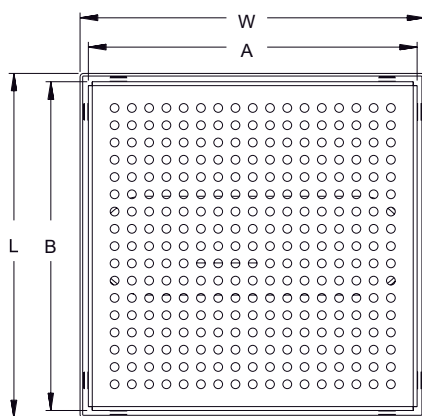

Code	W	L	H	Ø D	A	B	E
	200	200	91	49.5	188	188	1.5

Code	W	L	H	Ø D	A	B	E
	200	200	148	49.5	188	188	1.5

Table measure "mm"

# FLOOR DRAINS

# h10

## ECO 10x10



**NEW!**

Code	Outlet	Length		Price \$
------	--------	--------	--	----------

3011.0Y050K.010.1	Ø 50	10x10 cm	100	1,25
-------------------	------	----------	-----	------

\*Plastic body / Stainless grid / Odor blocking by water  
 \*пластичное тело / Нержавеющая щетка / Гидрозатвор  
 هيكل بلاستيكي / شبكة مقاومة للصدأ / حابس رائحة مائي بصمام

## LINE 10x10



Code	Outlet	Length		Price \$
------	--------	--------	--	----------

3012.0Y032K.010.1	Ø 32	10x10 cm	75	1,67
3012.0Y040K.010.1	Ø 40	10x10 cm	50	1,78
3012.0Y050K.010.1	Ø 50	10x10 cm	50	1,67
3012.0Y070K.010.1	Ø 70	10x10 cm	30	2,17

3012.0A040K.010.1	Ø 40	10x10 cm	60	1,67
3012.0A050K.010.1	Ø 50	10x10 cm	60	1,67
3012.0A070K.010.1	Ø 70	10x10 cm	60	2,17

\*Plastic body / Stainless grid / Odor blocking by water  
 \*пластичное тело / Нержавеющая щетка / Гидрозатвор  
 هيكل بلاستيكي / شبكة مقاومة للصدأ / حابس رائحة مائي بصمام

## LINE GOLD10x10



Code	Outlet	Length		Price \$
------	--------	--------	--	----------

3012.0Y032G.010.1	Ø 32	10x10 cm	75	2,23
3012.0Y040G.010.1	Ø 40	10x10 cm	50	2,37
3012.0Y050G.010.1	Ø 50	10x10 cm	50	2,23
3012.0Y070G.010.1	Ø 70	10x10 cm	30	2,78

3012.0A040G.010.1	Ø 40	10x10 cm	60	2,23
3012.0A050G.010.1	Ø 50	10x10 cm	60	2,23
3012.0A070G.010.1	Ø 70	10x10 cm	50	2,78

\*Plastic body / Stainless grid / Odor blocking by water  
 \*пластичное тело / Нержавеющая щетка / Гидрозатвор  
 هيكل بلاستيكي / شبكة مقاومة للصدأ / حابس رائحة مائي بصمام

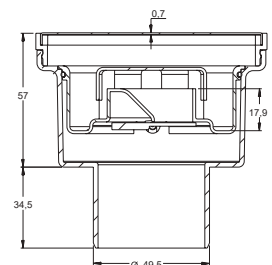
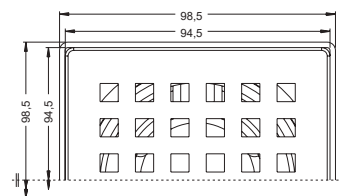
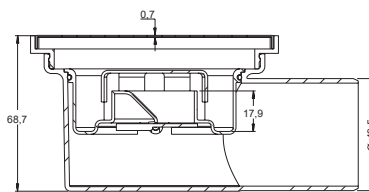
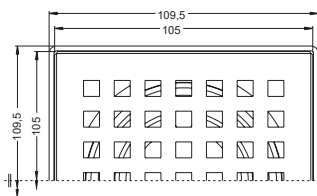

# FLOOR DRAINS

h10

## LINE 15x15



Code      Outlet      Length           Price \$

3012.0Y032K.015.1	Ø 32	15x15 cm	40	3,57
3012.0Y040K.015.1	Ø 40	15x15 cm	30	3,65
3012.0Y050K.015.1	Ø 50	15x15 cm	30	3,57
3012.0Y070K.015.1	Ø 70	15x15 cm	20	4,03

3012.0A040K.015.1	Ø 40	15x15 cm	30	3,57
3012.0A050K.015.1	Ø 50	15x15 cm	30	3,57
3012.0A070K.015.1	Ø 70	15x15 cm	30	4,03

\*Plastic body / Stainless grid / Odor blocking by water  
 \*пластичное тело / Нержавеющая щетка / Гидрозатвор  
 هيكل بلاستيكي / شبكة مقاومة للصدأ / حابس رائحة مائي بصمام

## LINE GOLD15x15

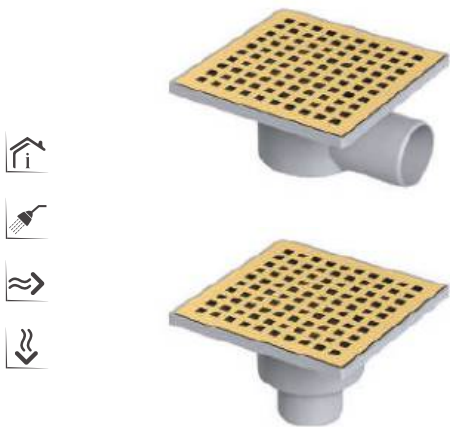

Code      Outlet      Length           Price \$

3012.0Y032G.015.1	Ø 32	15x15 cm	40	5,23
3012.0Y040G.015.1	Ø 40	15x15 cm	30	5,50
3012.0Y050G.015.1	Ø 50	15x15 cm	30	5,23
3012.0Y070G.015.1	Ø 70	15x15 cm	20	5,70

3012.0A040G.015.1	Ø 40	15x15 cm	30	5,23
3012.0A050G.015.1	Ø 50	15x15 cm	30	5,23
3012.0A070G.015.1	Ø 70	15x15 cm	30	5,70

\*Plastic body / Stainless grid / Odor blocking by water  
 \*пластичное тело / Нержавеющая щетка / Гидрозатвор  
 هيكل بلاستيكي / شبكة مقاومة للصدأ / حابس رائحة مائي بصمام

DN 50 side and vertical outlet - compatible with PVC pipe connections, common use of bathroom shower, hospital and hotel shower areas, locker-room shower areas etc.

Resistant against external chemical effects, operating temperature is between -30°C and +75°C. The grid is made of 304 grade stainless steel.

Grid patterns can be chosen in gold, bronze or other optional colors in accordance with your desire.

With its 304 grade stainless steel grid, it has a quality and stylish-looking. It can be easily applied at floor. With its odor blocking by water support, it prevents the bad smell coming from the installation. With its adjustable height legs, it can be adjusted depending on the screed concrete. High resistance against the organic and inorganic chemicals, resistant against most acidic and vertically aqueous oxidation.

It is not recommended to use high-density cleaners for a long-time.

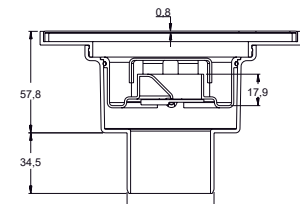
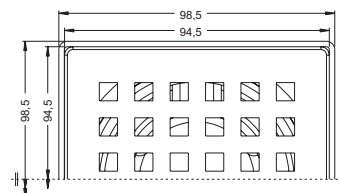
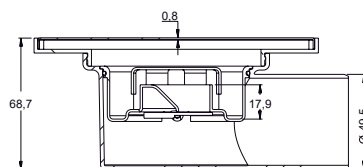
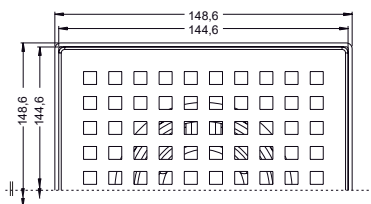

SQUARE



ALFA



ENDEKS



SG

# FLOOR DRAINS

# h10

## LEGAL 10x10



Code      Outlet      Length           Price \$

3013.0Y032K.010.1	Ø 32	10x10 cm	75	2,78
3013.0Y040K.010.1	Ø 40	10x10 cm	50	3,07
3013.0Y050K.010.1	Ø 50	10x10 cm	50	2,78
3013.0Y070K.010.1	Ø 70	10x10 cm	30	3,28

3013.0A040K.010.1	Ø 40	10x10 cm	60	2,78
3013.0A050K.010.1	Ø 50	10x10 cm	60	2,78
3013.0A070K.010.1	Ø 70	10x10 cm	50	3,28

\*Plastic body / Stainless grid / Stainless frame / Odor blocking with vet and dry system  
 \*пластичное тело / Нержавеющая решетка и рама / Гидрозатвор

هيكل بلاستيكي / شبكة وإطار مقاوم للصدأ / حابس رائحة مائي بصمام

## LEGAL 15x15



Code      Outlet      Length           Price \$

3013.0Y032K.015.1	Ø 32	15x15 cm	40	5,28
3013.0Y040K.015.1	Ø 40	15x15 cm	30	5,57
3013.0Y050K.015.1	Ø 50	15x15 cm	30	5,28
3013.0Y070K.015.1	Ø 70	15x15 cm	20	5,82

3013.0A040K.015.1	Ø 40	15x15 cm	30	5,28
3013.0A050K.015.1	Ø 50	15x15 cm	30	5,28
3013.0A070K.015.1	Ø 70	15x15 cm	30	5,82

\*Plastic body / Stainless grid / Stainless frame / Odor blocking with vet and dry system  
 \*пластичное тело / Нержавеющая решетка и рама / Гидрозатвор

هيكل بلاستيكي / شبكة وإطار مقاوم للصدأ / حابس رائحة مائي بصمام

DN 50 side and vertical outlet - compatible with PVC pipe connections, blocking odor by water support. Common use of bathroom shower, hospital and hotel shower areas, locker-room shower areas etc. The flow rate is 32 liters/min. Resistant against external chemical effects, operating temperature is between -30°C and +75°C. The grid is made of 304 grade stainless steel.

With its 304 grade stainless steel grid, it has a quality and stylish-looking. It can be easily applied at floor. With its odor blocking by water support, it prevents the bad smell coming from the installation. With its adjustable height legs, it can be adjusted depending on the screed concrete. High resistance against the organic and inorganic chemicals, resistant against most acidic and vertically aqueous oxidation. Grid patterns can be chosen in gold, bronze or other optional colors in accordance with your desire. It is not recommended to use high-density cleaners for a long-time.

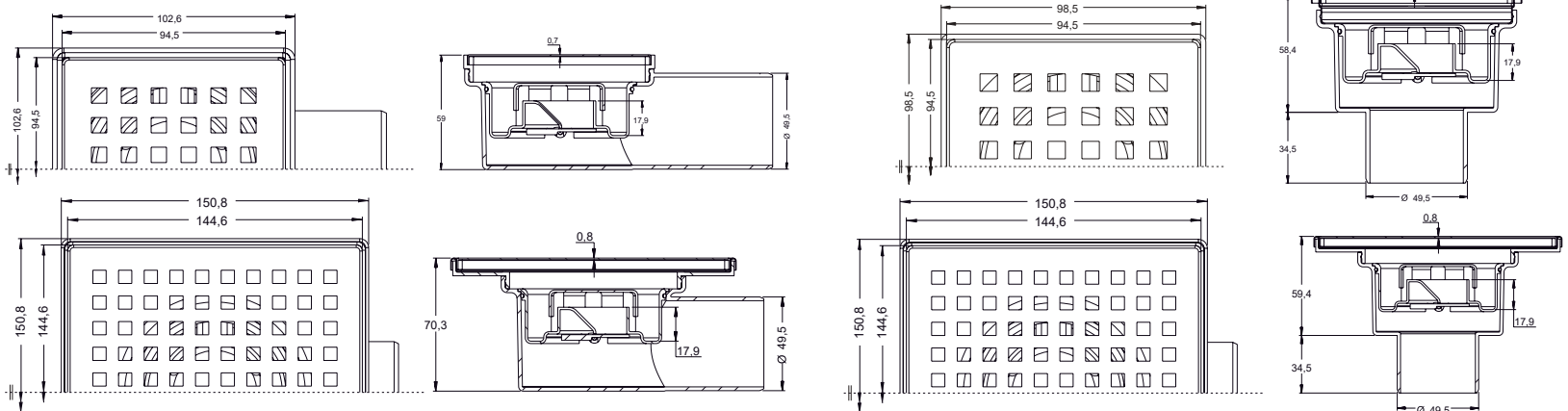

## FLOOR DRAINS

### MIDI10x10



Code      Outlet      Length           Price \$

5001.0Y032.010.1	Ø 32	10x10 cm	30	3,33
5001.0Y040.010.1	Ø 40	10x10 cm	20	3,54
5001.0Y050.010.1	Ø 50	10x10 cm	20	3,33
5001.0Y070.010.1	Ø 70	10x10 cm	20	3,46

5001.0A040.010.1	Ø 40	10x10 cm	20	3,54
5001.0A050.010.1	Ø 50	10x10 cm	20	3,33
5001.0A070.010.1	Ø 70	10x10 cm	20	3,46

Plastic body / Stainless grid / Odor trap  
 пластичное тело / Нержавеющая щетка / Мокрый Затвор

هيكل بلاستيكي / شبكة مقاومة للصدأ / حاجس رائحة مياه مع ك لاپا

### STD. 10x10



Code      Outlet      Length           Price \$

5002.0Y032.010.1	Ø 32	10x10 cm	30	5,53
5002.0Y040.010.1	Ø 40	10x10 cm	20	5,60
5002.0Y050.010.1	Ø 50	10x10 cm	20	5,60
5002.0Y070.010.1	Ø 70	10x10 cm	20	5,87
5002.0Y100.010.1	Ø 100	10x10 cm	10	6,37

5002.0A040.010.1	Ø 40	10x10 cm	20	5,40
5002.0A050.010.1	Ø 50	10x10 cm	20	5,40
5002.0A070.010.1	Ø 70	10x10 cm	20	5,40
5002.0A100.010.1	Ø 100	10x10 cm	10	5,40

Plastic body / Stainless grid / Odor trap  
 пластичное тело / Нержавеющая щетка / Мокрый Затвор

هيكل بلاستيكي / شبكة مقاومة للصدأ / حاجس رائحة مياه مع ك لاپا

DN 50 side and vertical outlet - compatible with PVC pipe connections, blocking odor by water support. Common use of bathroom shower, hospital and hotel shower areas, locker-room shower areas etc.

The flow rate is 32 liters/min. Resistant against external chemical effects, operating temperature is between -30°C and +75°C. The grid is made of 304 grade stainless steel.

Grid patterns can be chosen in gold, bronze or other optional colors in accordance with your desire.

With its 304 grade stainless steel grid, it has a quality and stylish-looking. It can be easily applied at floor. With its odor blocking by water support, it prevents the bad smell coming from the installation. With its adjustable height legs, it can be adjusted depending on the screed concrete. High resistance against the organic and inorganic chemicals, resistant against most acidic and vertically aqueous oxidation.

It is not recommended to use high-density cleaners for a long-time.

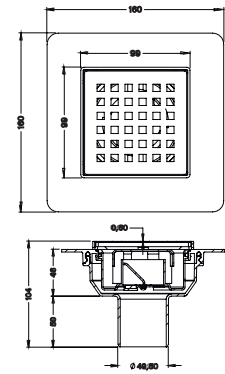
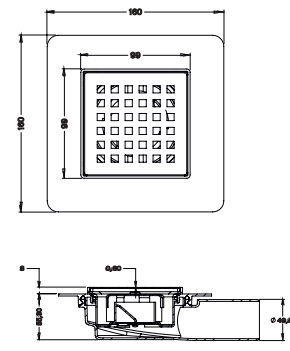
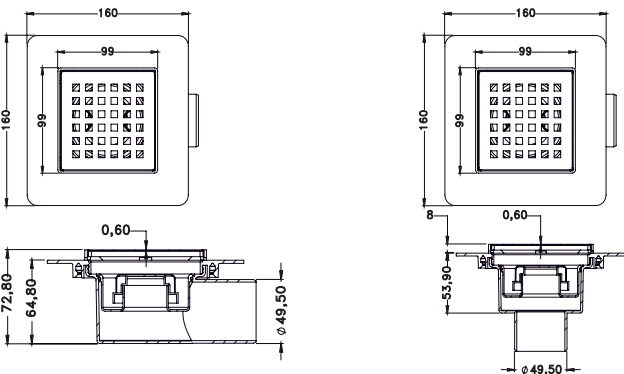

SQUARE      ALFA      ENDEKS

# FLOOR DRAINS

# h10

## MESH 10x10



Code      Outlet      Length           Price \$

5002.FY032.010.1	Ø 32	10x10 cm	30	5,93
5002.FY040.010.1	Ø 40	10x10 cm	20	6,00
5002.FY050.010.1	Ø 50	10x10 cm	20	6,00
5002.FY070.010.1	Ø 70	10x10 cm	20	6,27
5002.FY100.010.1	Ø 100	10x10 cm	10	6,77

5002.FA040.010.1	Ø 40	10x10 cm	20	5,80
5002.FA050.010.1	Ø 50	10x10 cm	20	5,80
5002.FA070.010.1	Ø 70	10x10 cm	20	5,80
5002.FA100.010.1	Ø 100	10x10 cm	10	5,80

Plastic body / Ss Grid / Odor trap / Mesh  
 пластичное тело / Нержавеющая щетка / Мокрый Затвор/Сеть  
 شبكة مقاومة للصدأ / مع شبكة / حابس رائحة مياه مع 5 لاپا / هيكل بلاستيكي

## T. MEMBRANE 10x10

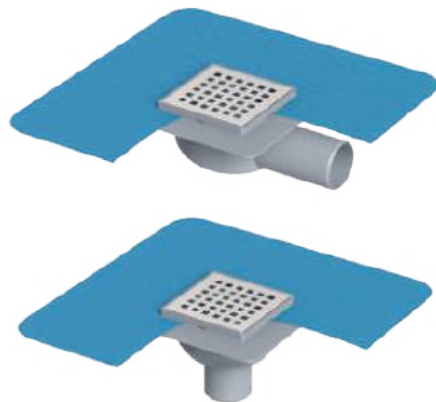

Code      Outlet      Length           Price \$

5002.TY032.010.1	Ø 32	10x10 cm	30	6,48
5002.TY040.010.1	Ø 40	10x10 cm	20	6,53
5002.TY050.010.1	Ø 50	10x10 cm	20	6,53
5002.TY070.010.1	Ø 70	10x10 cm	20	6,82
5002.TY100.010.1	Ø 100	10x10 cm	10	7,28

5002.TA040.010.1	Ø 40	10x10 cm	20	6,35
5002.TA050.010.1	Ø 50	10x10 cm	20	6,35
5002.TA070.010.1	Ø 70	10x10 cm	20	6,35
5002.TA100.010.1	Ø 100	10x10 cm	10	6,35

Plastic body / Ss Grid / Odor trap / Membrane  
 пластичное тело / Нержавеющая щетка / Мокрый Затвор/Мембраны  
 شبكة مقاومة للصدأ / مع غشاء النسيج / حابس رائحة مياه مع 5 لاپا / هيكل بلاستيكي

DN 50 side and vertical outlet - compatible with PVC pipe connections, blocking odor by Common use of bathroom shower, hospital and hotel shower areas, locker-room water (36mm). The flow rate is 32 liters/min. shower areas etc.

Resistant against external chemical effects, operating temperature is between -30°C and +75°C. The grid is made of 304 grade stainless steel.

Grid patterns can be chosen in gold, bronze or other optional colors in accordance with your desire.

With its 304 grade stainless steel grid, it has a quality and stylish-looking. It can be easily applied at floor. With its odor blocking by water support, it prevents the bad smell coming from the installation. With its adjustable height legs, it can be adjusted depending on the screed concrete. High resistance against the organic and inorganic chemicals, resistant against most acidic and vertically aqueous oxidation.

It is not recommended to use high-density cleaners for a long-time.

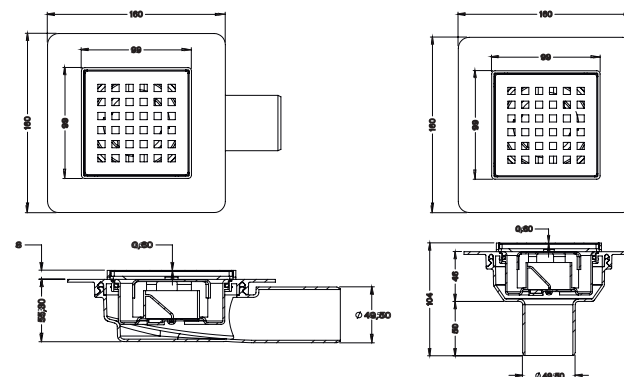
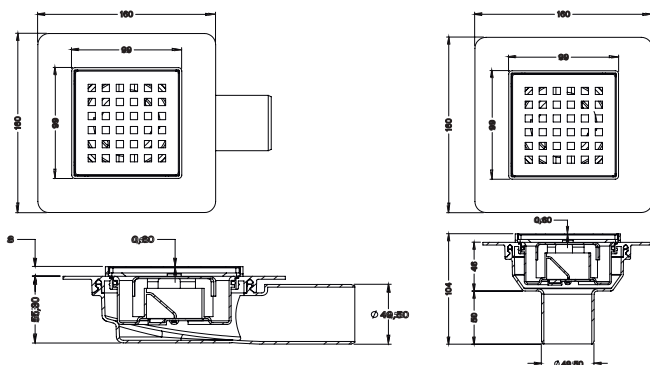

SQUARE

ALFA

ENDEKS

# FLOOR DRAINS

h10

## KUCA

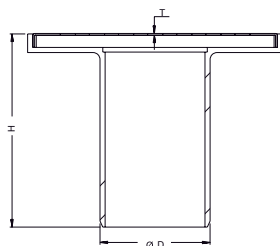
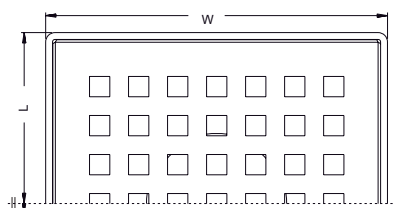

Code      Outlet      Length           Price \$

5710.0A050K.010.1	Ø 50	10x10 cm	60	2,78
5710.0A070K.010.1	Ø 70	10x10 cm	60	2,92

\*Plastic body / Stainless grid  
\*пластичное тело / Нержавеющая щетка  
هيكل بلاستيكي / شبكة مقاومة للصدأ

PART NO	PART DESCRIPTION	MATERIAL	PCS
5710.1	Stainless grid	AISI 304	1
5710.2	Plastic body	PP	1

Code	W	L	H	Ø D	E
5710.0A050.10.1	109.5	109.5	83	49.5	0.7
5710.0A070.10.1	109.5	109.5	83	74.5	0.7

## BALCONY DRAINER



Code      Outlet           Price \$

6001.0A070.13.0	Ø 70	125	3,43
-----------------	------	-----	------

Plastic body  
пластичное тело  
هيكل بلاستيكي

6002.0A100.16.0	Ø 100	64	3,80
-----------------	-------	----	------

Plastic body  
пластичное тело  
هيكل بلاستيكي

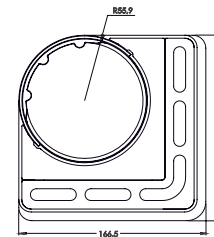
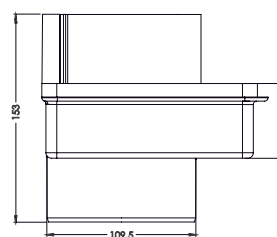
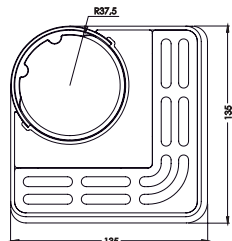
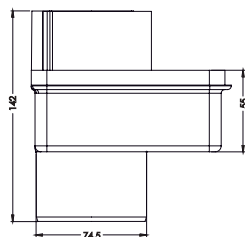



# FLOOR DRAINS

# h10

## SCALA 10x10

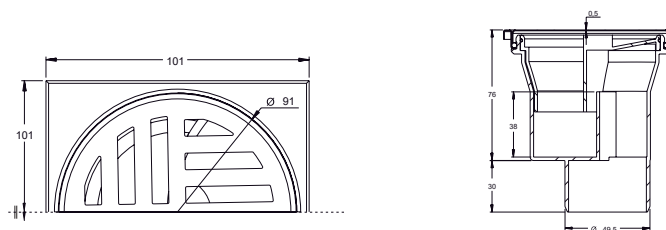
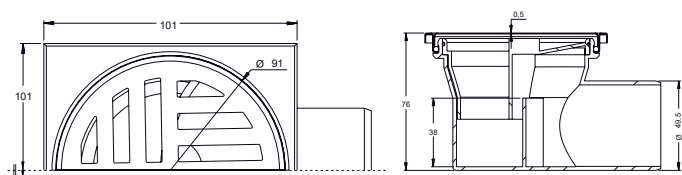

## SCALA 15x15

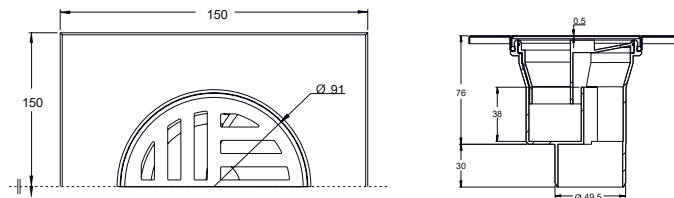
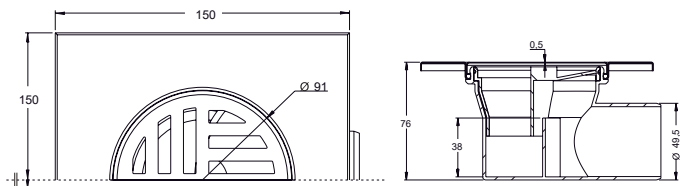

Code	Outlet	Length		Price \$
------	--------	--------	--	----------

3014.0Y032K.010.9	Ø 32	10x10 cm	50	2,50
-------------------	------	----------	----	------

3014.0Y050K.010.9	Ø 50	10x10 cm	50	2,65
-------------------	------	----------	----	------

3014.0A050K.010.9	Ø 50	10x10 cm	50	2,65
-------------------	------	----------	----	------

\*Plastic body / Stainless steel grid and frame / Odor blocking by water  
\*пластичное тело / Нержавеющая решетка и рама / Гидрозатвор

هيكل بلاستيكي / شبكة وإطار مقاوم للصدأ / حابس رائحة مائي بصمام

Code	Outlet	Length		Price \$
------	--------	--------	--	----------

3014.0Y032K.015.9	Ø 32	15x15 cm	30	3,50
-------------------	------	----------	----	------

3014.0Y050K.015.9	Ø 50	15x15 cm	30	3,58
-------------------	------	----------	----	------

3014.0A050K.015.9	Ø 50	15x15 cm	24	3,58
-------------------	------	----------	----	------

\*Plastic body / Stainless steel grid and frame / Odor blocking by water  
\*пластичное тело / Нержавеющая решетка и рама / Гидрозатвор

هيكل بلاستيكي / شبكة وإطار مقاوم للصدأ / حابس رائحة مائي بصمام

## FLOOR DRAINS

### LIBRA 10x10



Code

Outlet

Length



Price \$

3065.0A050K.10.1	Ø 50	10x10 cm	50	15,07
------------------	------	----------	----	-------

Stainless Steel Body / Tile Insertable Grid

3065.0Y050K.10.1	Ø 50	10x10 cm	50	15,84
------------------	------	----------	----	-------

Stainless Steel Body / Tile Insertable Grid

3066.0Y050K.10.1	Ø 50	10x10 cm	50	15,84
------------------	------	----------	----	-------

Stainless Steel Body / Tile Insertable Grid

### LIBRA 15x15



Code

Outlet

Length



Price \$

3065.0A050K.015.1	Ø 50	15x15 cm	50	20,34
-------------------	------	----------	----	-------

Stainless Steel Body / Tile Insertable Grid

3065.0Y050K.015.1	Ø 50	15x15 cm	50	21,00
-------------------	------	----------	----	-------

Stainless Steel Body / Tile Insertable Grid

3014.0A050K.010.9	Ø 50	15x15 cm	50	21,00
-------------------	------	----------	----	-------

Stainless Steel Body / Tile Insertable Grid

# STAINLESS FLOOR DRAINS

h10

## PREMIUM 10x10

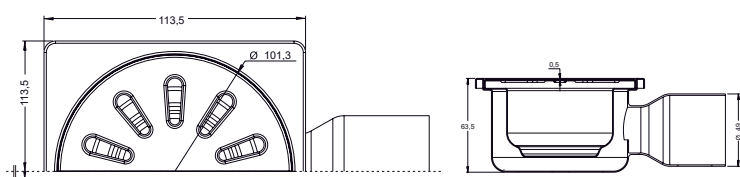

Code      Outlet      Length           Price \$

3045.0Y032K.010.1      Ø 32      10x10 cm      24      11,12

3045.0Y050K.010.1      Ø 50      10x10 cm      24      11,67

3045.0A050K.010.1      Ø 50      10x10 cm      24      11,67

\*Stainless body / Stainless steel grid / Stainless scent holder  
 \*Корпус Из Нержавеющей / Нержавеющая щетка / Гидрозатвор  
 هيكل مقاوم للصدأ / شبكة مقاومة للصدأ / حابس رائحة / غير القابل للصدأ

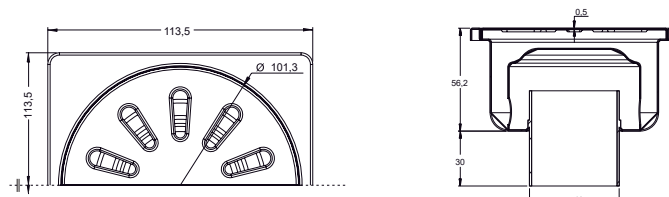

## PREMIUM 15x15

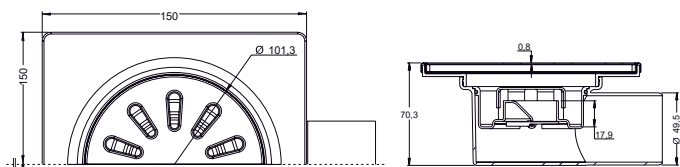

Code      Outlet      Length           Price \$

3045.0Y032K.015.1      Ø 32      15x15 cm      24      13,12

3045.0Y050K.015.1      Ø 50      15x15 cm      24      13,58

3045.0Y070K.015.1      Ø 70      15x15 cm      24      13,45

3045.0A050K.015.1      Ø 50      15x15 cm      24      12,78

3045.0A070K.015.1      Ø 70      15x15 cm      24      14,08

\*Stainless body / Stainless steel grid / Stainless scent holder  
 \*Корпус Из Нержавеющей / Нержавеющая щетка / Гидрозатвор  
 هيكل مقاوم للصدأ / شبكة مقاومة للصدأ / حابس رائحة / غير القابل للصدأ

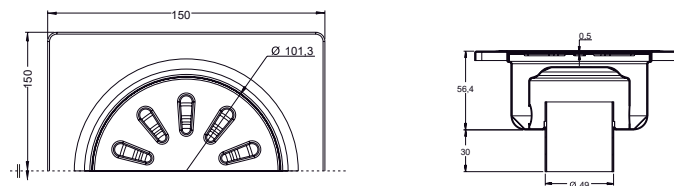

# STAINLESS FLOOR DRAINS

h10

## PREMIUM 20x20

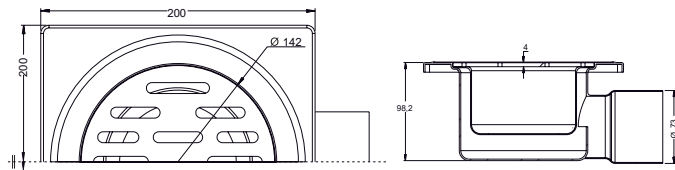

Code	Outlet	Length		Price \$
------	--------	--------	--	----------

3045.0Y070K.020.1	Ø 50	20x20 cm	12	47,97
3045.0Y100K.020.1	Ø 100	20x20 cm	12	52,45
<hr/>				
3045.0A070K.020.1	Ø 70	20x20 cm	12	47,97
3045.0A100K.020.1	Ø 100	20x20 cm	12	52,45

\*Stainless body / Stainless steel grid / Stainless scent holder  
 \*Корпус Из Нержавеющей / Нержавеющая щетка / Гидрозатвор  
 هيكل مقاوم للصدأ / شبكة مقاومة للصدأ / حابس رائحة / غير القابل للصدأ

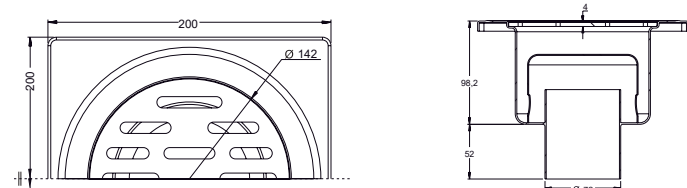

## PREMIUM SLIM 10x10

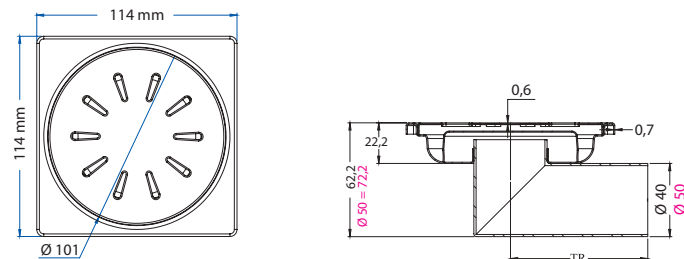
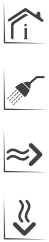

Code	Outlet	Length		Price \$
------	--------	--------	--	----------

3046.0Y040K.010.1	Ø 40	10x10 cm	50	12,03
3046.0Y050K.010.1	Ø 50	10x10 cm	50	12,28
<hr/>				
3046.0A040K.010.1	Ø 40	10x10 cm	50	9,75
3046.0A050K.010.1	Ø 50	10x10 cm	50	10,12

\*Stainless body / Stainless steel grid / Stainless scent holder  
 \*Корпус Из Нержавеющей / Нержавеющая щетка / Гидрозатвор  
 هيكل مقاوم للصدأ / شبكة مقاومة للصدأ / حابس رائحة / غير القابل للصدأ

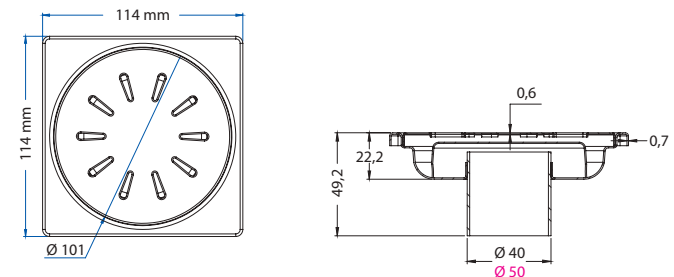

# STAINLESS FLOOR DRAINS

h10

## PREMIUM SLIM 15x15

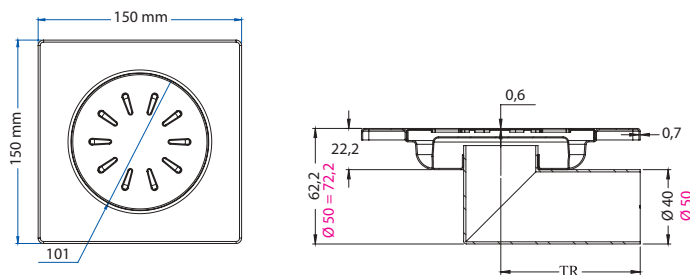

Code      Outlet      Length           Price \$

3046.0Y040K.015.1	Ø 40	15x15 cm	50	13,08
3046.0Y050K.015.1	Ø 50	15x15 cm	50	13,32
<hr/>				
3046.0A040K.015.1	Ø 40	15x15 cm	50	11,63
3046.0A050K.015.1	Ø 50	15x15 cm	50	11,98

\*Stainless body / Stainless steel grid / Stainless scent holder  
 \*Корпус Из Нержавеющей / Нержавеющая щетка / Гидрозатвор  
 هيكل مقاوم للصدأ / شبكة مقاومة للصدأ / حابس رائحة / غير القابل للصدأ

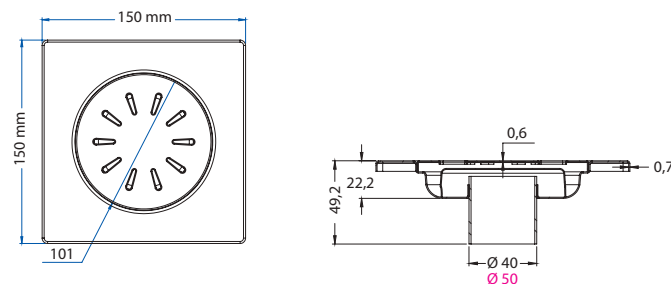

## PREMIUM SLIM 20x20

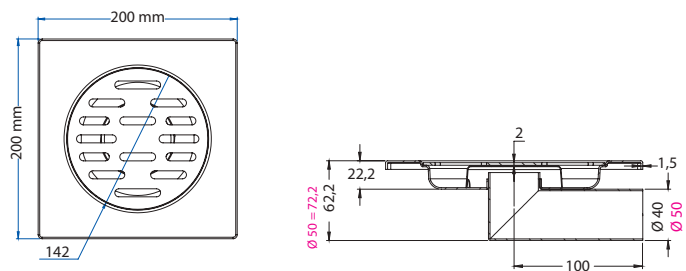

Code      Outlet      Length           Price \$

3046.0Y040K.020.1	Ø 40	20x20 cm	24	32,42
3046.0Y050K.020.1	Ø 50	20x20 cm	24	32,42
<hr/>				
3046.0A040K.020.1	Ø 40	20x20 cm	24	26,93
3046.0A050K.020.1	Ø 50	20x20 cm	24	27,32

\*Stainless body / Stainless steel grid / Stainless scent holder  
 \*Корпус Из Нержавеющей / Нержавеющая щетка / Гидрозатвор  
 هيكل مقاوم للصدأ / شبكة مقاومة للصدأ / حابس رائحة / غير القابل للصدأ

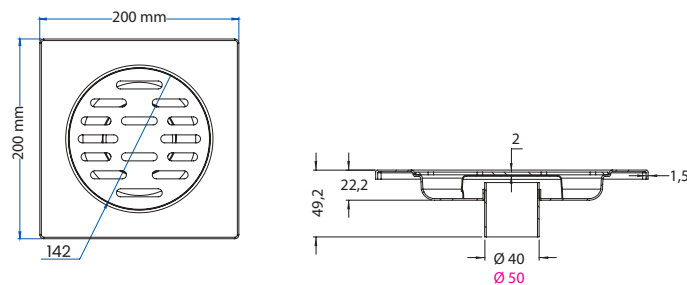

# REFLECTION COVERS

# h10

## PEARL



Code	W	L	H	Ø D	Ø D1	E	E1	X
3155.1515P0.120.0	150	150	13	102.5	107	1.2	1.2	-
3155.1515P0.150.0	150	150	13	102.5	107	1.5	1.5	-
3155.1515P1.120.0	150	150	13	102.5	107	1.2	1.2	7.8
3155.1515P1.150.0	150	150	13	102.5	107	1.5	1.5	7.8
3155.2020P0.150.0	200	150	13	102.5	107	1.2	1.2	-
3155.2020P1.150.0	200	150	13	102.5	107	1.5	1.5	7.8

Code	Açıklama	Length		Price \$
------	----------	--------	--	----------

3155.1515P0.120.0	Without lap 1.20 mm	15x15 cm	50	7,25
3155.1515P0.150.0	Without lap 1.50 mm	15x15 cm	50	8,48
3155.1515P1.120.0	With lap 1.20 mm	15x15 cm	50	7,62
3155.1515P1.150.0	With lap 1.50 mm	15x15 cm	50	9,07
3155.2020P0.150.0	Without lap 1.50 mm	20x20 cm	40	12,23
3155.2020P1.150.0	With lap 1.50 mm	20x20 cm	40	12,90

Stainless body / Корпус Из Нержавеющей

هيكل مقاوم للصدأ

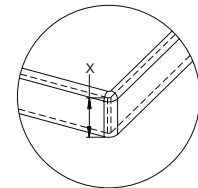
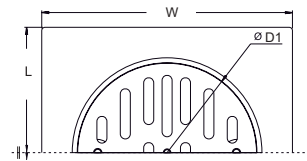

## QUATTRO



Code	W	L	H	Ø D	Ø D1	E	E1	X
3159.1515P0.120.0	150	150	13	102.5	107	1.2	1.2	-
3159.1515P0.150.0	150	150	13	102.5	107	1.5	1.5	-
3159.1515P1.120.0	150	150	13	102.5	107	1.2	1.2	7.8
3159.1515P1.150.0	150	150	13	102.5	107	1.5	1.5	7.8
3159.2020P0.150.0	200	150	13	102.5	107	1.2	1.2	-
3159.2020P1.150.0	200	150	13	102.5	107	1.5	1.5	7.8

Code	Açıklama	Length		Price \$
------	----------	--------	--	----------

3159.1515P0.120.0	Without lap 1.20 mm	15x15 cm	50	9,45
3159.1515P0.150.0	Without lap 1.50 mm	15x15 cm	50	11,07
3159.1515P1.120.0	With lap 1.20 mm	15x15 cm	50	9,83
3159.1515P1.150.0	With lap 1.50 mm	15x15 cm	50	11,60
3159.2020P0.150.0	Without lap 1.50 mm	20x20 cm	40	15,40
3159.2020P1.150.0	With lap 1.50 mm	20x20 cm	40	16,08

Stainless body / Корпус Из Нержавеющей

هيكل مقاوم للصدأ

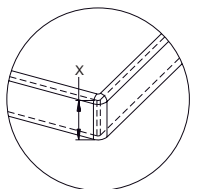
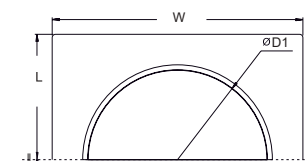

# REFLECTION COVERS

h10

## DREAM



Code	W	L	H	Ø D	Ø D1	E	E1	X
3158.1515P0.120.0	150	150	13	102.5	107	1.2	1.2	-
3158.1515P0.150.0	150	150	13	102.5	107	1.5	1.5	-
3158.1515P1.120.0	150	150	13	102.5	107	1.2	1.2	7.8
3158.1515P1.150.0	150	150	13	102.5	107	1.5	1.5	7.8
3158.2020P0.150.0	200	150	13	102.5	107	1.2	1.2	-
3158.2020P1.150.0	200	150	13	102.5	107	1.5	1.5	7.8

Code

Açıklama

Length



Price \$

3158.1515P0.120.0	Without lap 1.20 mm	15x15 cm	50	9,28
3158.1515P0.150.0	Without lap 1.50 mm	15x15 cm	50	10,90
3158.1515P1.120.0	With lap 1.20 mm	15x15 cm	50	9,67
3158.1515P1.150.0	With lap 1.50 mm	15x15 cm	50	11,45
3158.2020P0.150.0	Without lap 1.50 mm	20x20 cm	40	15,23
3158.2020P1.150.0	With lap 1.50 mm	20x20 cm	40	15,92

Stainless body / Корпус Из Нержавеющей

هيكل مقاوم للصدا

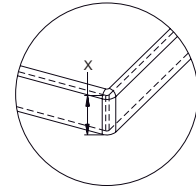
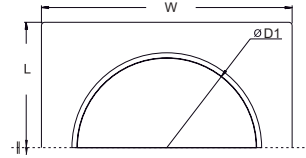

## NILE



Code	W	L	H	Ø D	Ø D1	E	E1	X
3156.1515P0.120.0	150	150	13	102.5	107	1.2	1.2	-
3156.1515P0.150.0	150	150	13	102.5	107	1.5	1.5	-
3156.1515P1.120.0	150	150	13	102.5	107	1.2	1.2	7.8
3156.1515P1.150.0	150	150	13	102.5	107	1.5	1.5	7.8
3156.2020P0.150.0	200	150	13	102.5	107	1.2	1.2	-
3156.2020P1.150.0	200	150	13	102.5	107	1.5	1.5	7.8

Code

Açıklama

Length



Price \$

3156.1515P0.120.0	Without lap 1.20 mm	15x15 cm	50	9,28
3156.1515P0.150.0	Without lap 1.50 mm	15x15 cm	50	10,90
3156.1515P1.120.0	With lap 1.20 mm	15x15 cm	50	9,67
3156.1515P1.150.0	With lap 1.50 mm	15x15 cm	50	11,45
3156.2020P0.150.0	Without lap 1.50 mm	15x15 cm	40	15,23
3156.2020P1.150.0	With lap 1.50 mm	15x15 cm	40	15,92

Stainless body / Корпус Из Нержавеющей

هيكل مقاوم للصدا

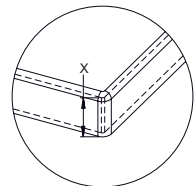
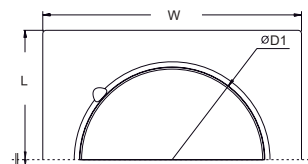

# SIPHON UPPER BODY

h10

## LINE 10x10



Code	Diameter	Length		Price \$
------	----------	--------	--	----------

5101.0A100.10.1	Ø 100	10x10 cm	150	3,45
-----------------	-------	----------	-----	------

\*Plastic body / Stainless steel grid / Odor blocking by waters  
 \*пластичное тело / Гидро и сухой затвор / Нержавеющая щетка  
 هيكل بلاستيكي / شبكة مقاومة للصدأ / حابس رائحة / بصمام مائي

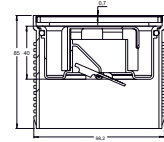
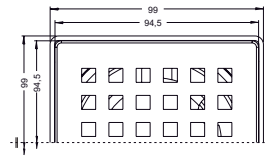

## LINE 15x15



Code	Diameter	Length		Price \$
------	----------	--------	--	----------

5107.0A100.15.1	Ø 100	15x15 cm	80	5,21
-----------------	-------	----------	----	------

\*Plastic body / Stainless steel grid / Odor blocking by waters  
 \*пластичное тело / Гидро и сухой затвор / Нержавеющая щетка  
 هيكل بلاستيكي / شبكة مقاومة للصدأ / حابس رائحة / بصمام مائي

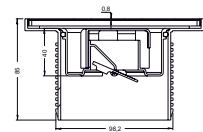
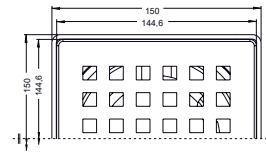

## LEGAL 10x10



Code	Diameter	Length		Price \$
------	----------	--------	--	----------

5102.0A100.10.1	Ø 100	10x10 cm	150	4,85
-----------------	-------	----------	-----	------

\*Plastic body / Stainless steel grid and frame / Odor blocking by waters  
 \*пластичное тело / Гидро и сухой затвор / Решетка из нержавеющей стали и рамка  
 هيكل بلاستيكي / شبكة وإطار مقاوم للصدأ / حابس رائحة / بصمام مائي

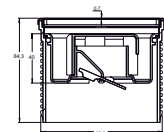
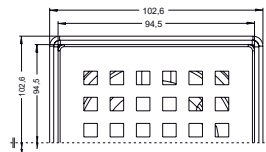

## LEGAL 15x15



Code	Diameter	Length		Price \$
------	----------	--------	--	----------

5108.0A100.15.1	Ø 100	15x15 cm	80	7,36
-----------------	-------	----------	----	------

\*Plastic body / Stainless steel grid and frame / Odor blocking by waters  
 \*пластичное тело / Гидро и сухой затвор / Решетка из нержавеющей стали и рамка  
 هيكل بلاستيكي / شبكة وإطار مقاوم للصدأ / حابس رائحة / بصمام مائي

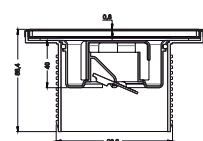
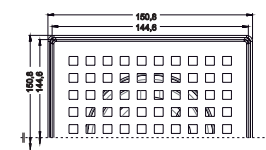



# SIPHON UPPER BODY

# h10

## SCALA 10x10



Code	Diameter	Length		Price \$
------	----------	--------	--	----------

5103.0A100.10.0	Ø 100	10x10 cm	120	2,75
-----------------	-------	----------	-----	------

\*Plastic body / Odor blocking by water / Compatible with ceramic Plastic interior frame  
\*пластичное тело / Сухой Затвор

السيراميك إطار الداخلية من البلاستيك / متوافق مع / ماني / بصمام / حابس رائحة / هيكل بلاستيكي / حابس رائحة

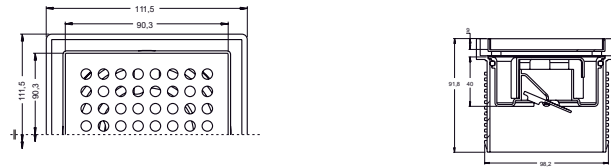

## SCALA 15x15



Code	Diameter	Length		Price \$
------	----------	--------	--	----------

5109.0A100.15.0	Ø 100	15x15 cm	80	2,86
-----------------	-------	----------	----	------

\*Plastic body / Odor blocking by water / Compatible with ceramic Plastic interior frame  
\*пластичное тело / Сухой Затвор

السيراميك إطار الداخلية من البلاستيك / متوافق مع / ماني / بصمام / حابس رائحة / هيكل بلاستيكي / حابس رائحة

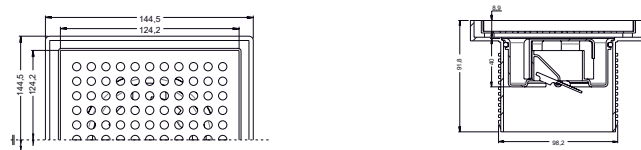

## ELiT 10x10



Code	Diameter	Length		Price \$
------	----------	--------	--	----------

5104.0A100.10.0	Ø 100	10x10 cm	120	6,64
-----------------	-------	----------	-----	------

\*Plastic body / Stainless interior and exterior frame / Odor blocking by water / Compatible with ceramic Plastic interior frame

\*пластичное тело / Гидро и сухой затвор Рама из нержавеющей стали

السيراميك أطر الداخلية من البلاستيك / المتوافق مع / حابس رائحة ماني بصمام / حابس رائحة للمقاومة للصدأ الداخلية والخارجية / هيكل بلاستيكي / أطر المقاوم للصدأ الداخلية والخارجية

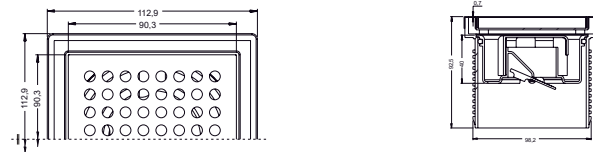

## ELiT 15x15



Code	Diameter	Length		Price \$
------	----------	--------	--	----------

5110.0A100.15.0	Ø 100	15x15 cm	80	8,42
-----------------	-------	----------	----	------

\*Plastic body / Stainless interior and exterior frame / Odor blocking by water / Compatible with ceramic Plastic interior frame

\*пластичное тело / Гидро и сухой затвор Рама из нержавеющей стали

السيراميك أطر الداخلية من البلاستيك / المتوافق مع / حابس رائحة ماني بصمام / حابس رائحة للمقاومة للصدأ الداخلية والخارجية / هيكل بلاستيكي / أطر المقاوم للصدأ الداخلية والخارجية

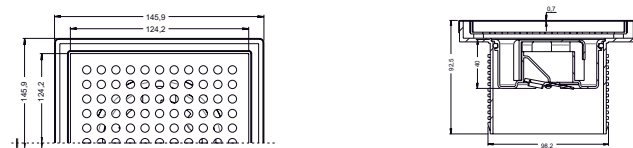

# SIPHON UPPER BODY

# h10

## PREMIUM 10x10



Code	Diameter	Length		Price \$
------	----------	--------	--	----------

5105.0A100.10.0	Ø 100	10x10 cm	120	6,59
-----------------	-------	----------	-----	------

\*Plastic body / Stainless steel outer frame and full cover / Odor blocking by water  
 \*пластичное тело / Гидро и сухой затвор Рама из нержавеющей стали и полное покрытие  
 / هيكل بلاستيكي / الإطار الخارجي الفولاذ المقاوم للصدأ والغطاء الكامل حابس رائحة / بصمام مائي

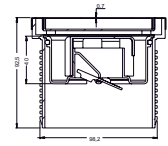
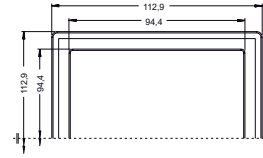

## PREMIUM 15x15



Code	Diameter	Length		Price \$
------	----------	--------	--	----------

5111.0A100.15.0	Ø 100	15x15 cm	80	8,40
-----------------	-------	----------	----	------

\*Plastic body / Stainless steel outer frame and full cover / Odor blocking by water  
 \*пластичное тело / Гидро и сухой затвор Рама из нержавеющей стали и полное покрытие  
 / هيكل بلاستيكي / الإطار الخارجي الفولاذ المقاوم للصدأ والغطاء الكامل حابس رائحة / بصمام مائي

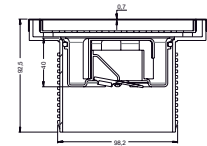
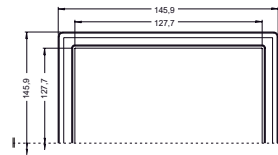

## RING



Code	Diameter	Length		Price \$
------	----------	--------	--	----------

1207001100100	Ø 100	-	150	2,13
---------------	-------	---	-----	------

Lifter tool  
 Обновление распорка  
 اداة ارتفاع

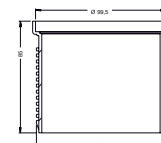
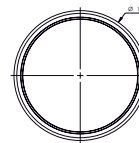

## RING



Code	Diameter	Length		Price \$
------	----------	--------	--	----------

5112.0A100.00.1	Ø 100	15x15 cm	150	2,81
-----------------	-------	----------	-----	------

\*Plastic body / Stainless steel grid / Odor blocking by waters  
 \*пластичное тело / Гидро и сухой затвор / Нержавеющая щетка  
 / هيكل بلاستيكي / شبكة مقاومة للصدأ / حابس رائحة / بصمام مائي



## INSULATION IN COMPLIANCE SIPHON

# INSULATION IN COMPLIANCE SIPHON

h10

## 140 MM DUVAR DİBİ



Code	Outlet	Length		Price \$
------	--------	--------	--	----------

5014.0Y032.00.0	Ø 32	46 mm	125	2,36
5014.0Y040.00.0	Ø 40	55 mm	125	2,43
5014.0Y050.00.0	Ø 50	55 mm	100	2,43
5014.0Y070.00.0	Ø 70	79 mm	75	2,68
5014.0Y100.00.0	Ø 100	115 mm	75	3,18

5014.0A040.00.0	Ø 40	96 mm	140	2,21
5014.0A050.00.0	Ø 50	96 mm	140	2,21
5014.0A070.00.0	Ø 70	96 mm	125	2,21
5014.0A100.00.0	Ø 100	96 mm	75	2,21

Siphon lower body / пластичное тело

الجسم السفلي

## 180 MM



Code	Outlet	Length		Price \$
------	--------	--------	--	----------

5018.0Y032.00.0	Ø 32	46 mm	100	2,53
5018.0Y040.00.0	Ø 40	55 mm	100	2,58
5018.0Y050.00.0	Ø 50	55 mm	100	2,58
5018.0Y070.00.0	Ø 70	79 mm	75	2,85
5018.0Y100.00.0	Ø 100	115 mm	30	3,35

5018.0A040.00.0	Ø 40	96 mm	100	2,36
5018.0A050.00.0	Ø 50	96 mm	100	2,36
5018.0A070.00.0	Ø 70	96 mm	85	2,36
5018.0A100.00.0	Ø 100	96 mm	75	2,36

Siphon lower body / пластичное тело

الجسم السفلي

## 210 MM



Code	Outlet	Length		Price \$
------	--------	--------	--	----------

5021.0Y032.00.0	Ø 32	46 mm	100	2,65
5021.0Y040.00.0	Ø 40	55 mm	100	2,70
5021.0Y050.00.0	Ø 50	55 mm	100	2,70
5021.0Y070.00.0	Ø 70	79 mm	70	2,96
5021.0Y100.00.0	Ø 100	115 mm	30	3,46

5021.0A040.00.0	Ø 40	96 mm	100	2,50
5021.0A050.00.0	Ø 50	96 mm	100	2,50
5021.0A070.00.0	Ø 70	96 mm	100	2,50
5021.0A100.00.0	Ø 100	96 mm	70	2,50

Siphon lower body / пластичное тело

الجسم السفلي

# INSULATION IN COMPLIANCE SIPHON

h10

## 140 MM MESH



Code

Outlet

Length



Price \$

5014.FY032.00.0	Ø 32	46 mm	125	2,83
5014.FY040.00.0	Ø 40	55 mm	125	2,88
5014.FY050.00.0	Ø 50	55 mm	100	2,88
5014.FY070.00.0	Ø 70	79 mm	75	3,15
5014.FY100.00.0	Ø 100	115 mm	75	3,65

5014.FA040.00.0	Ø 40	96 mm	100	2,68
5014.FA050.00.0	Ø 50	96 mm	100	2,68
5014.FA070.00.0	Ø 70	96 mm	75	2,68
5014.FA100.00.0	Ø 100	96 mm	75	2,68

Siphon lower body / пластиковое тело

الجسم السفلي

## 180 MM MESH



Code

Outlet

Length



Price \$

5018.FY032.00.0	Ø 32	46 mm	100	2,91
5018.FY040.00.0	Ø 40	55 mm	100	2,96
5018.FY050.00.0	Ø 50	55 mm	100	2,96
5018.FY070.00.0	Ø 70	79 mm	75	3,25
5018.FY100.00.0	Ø 100	115 mm	72	3,73

5018.FA040.00.0	Ø 40	96 mm	100	2,76
5018.FA050.00.0	Ø 50	96 mm	90	2,76
5018.FA070.00.0	Ø 70	96 mm	85	2,76
5018.FA100.00.0	Ø 100	96 mm	72	2,76

Siphon lower body / пластиковое тело

الجسم السفلي

## 140 MM T.MEMBRANE

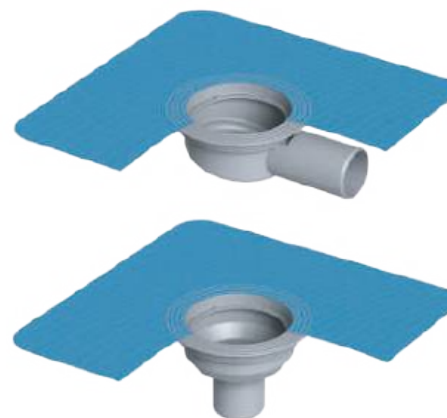

Code

Outlet

Length



Price \$

5014.TY032.00.0	Ø 32	46 mm	125	3,38
5014.TY040.00.0	Ø 40	55 mm	125	3,43
5014.TY050.00.0	Ø 50	55 mm	100	3,43
5014.TY070.00.0	Ø 70	79 mm	75	3,70
5014.TY100.00.0	Ø 100	115 mm	75	4,20

5014.TA040.00.0	Ø 40	96 mm	100	3,21
5014.TA050.00.0	Ø 50	96 mm	100	3,21
5014.TA070.00.0	Ø 70	96 mm	75	3,21
5014.TA100.00.0	Ø 100	96 mm	75	3,21

Siphon lower body / пластиковое тело

الجسم السفلي

# INSULATION IN COMPLIANCE SIPHON

h10

## 180 MM T.MEMBRANE

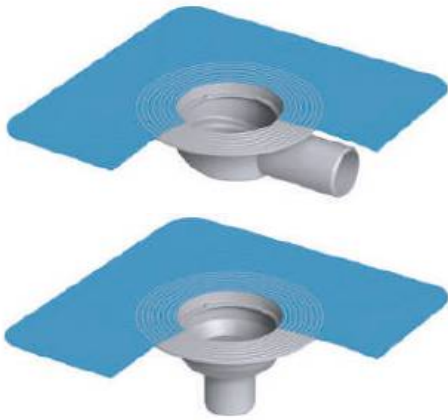

Code

Outlet

Length



Price \$

5018.TY032.00.0	Ø 32	46 mm	100	3,46
5018.TY040.00.0	Ø 40	55 mm	100	3,51
5018.TY050.00.0	Ø 50	55 mm	90	3,51
5018.TY070.00.0	Ø 70	79 mm	75	3,78
5018.TY100.00.0	Ø 100	115 mm	50	4,28

5018.TA040.00.0	Ø 40	96 mm	85	3,30
5018.TA050.00.0	Ø 50	96 mm	85	3,30
5018.TA070.00.0	Ø 70	96 mm	75	3,30
5018.TA100.00.0	Ø 100	96 mm	75	3,30

Siphon lower body / пластиковое тело

الجسم السفلي

## 210 MM MEMBRANE



Code

Outlet

Length



Price \$

5021.MY032.00.0	Ø 32	50 mm	35	6,31
5021.MY040.00.0	Ø 40	59 mm	35	6,36
5021.MY050.00.0	Ø 50	59 mm	35	6,36
5021.MY070.00.0	Ø 70	84 mm	30	6,63
5021.MY100.00.0	Ø 100	119 mm	30	7,13

5021.MA040.00.0	Ø 40	100 mm	30	6,14
5021.MA050.00.0	Ø 50	100 mm	30	6,14
5021.MA070.00.0	Ø 70	100 mm	30	6,14
5021.MA100.00.0	Ø 100	100 mm	30	6,14

Plastic body / Stainless Steel Flanges set

пластичное тело / Изоляция совместимый / Мембраны

الجسم السفلي فريق الفولاذ المقاوم للصدأ الشفاه

## VERTICAL Outlet

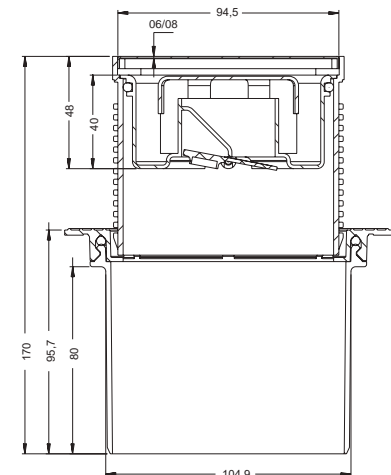
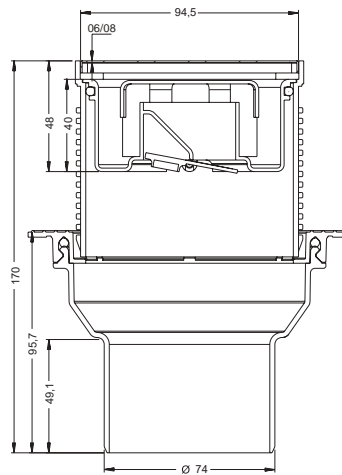
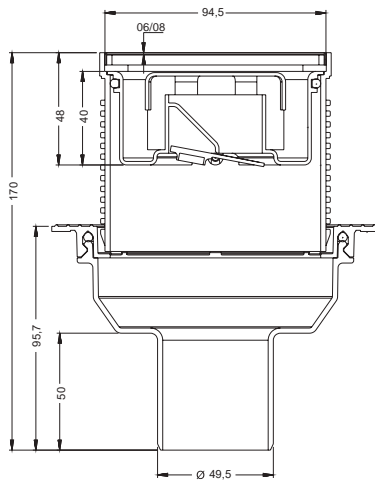

## SIDE Outlet

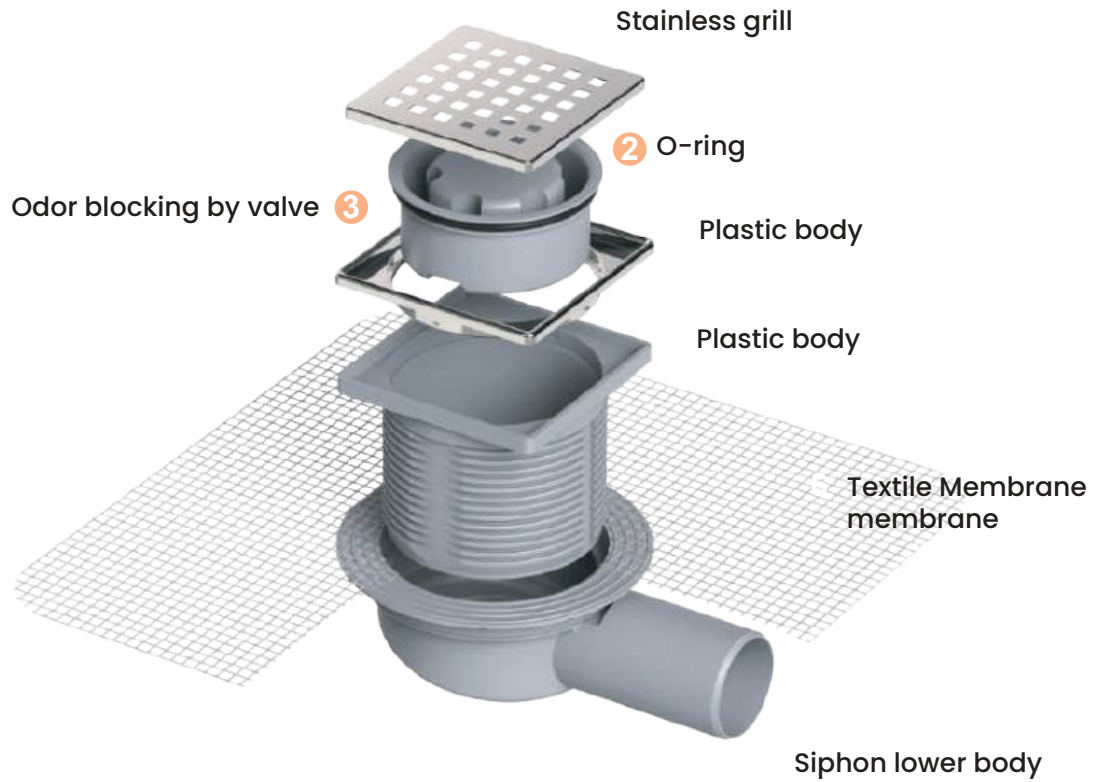
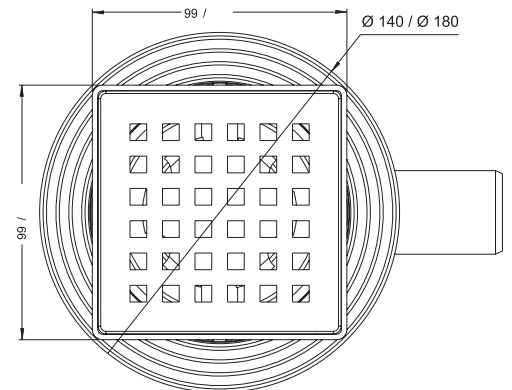
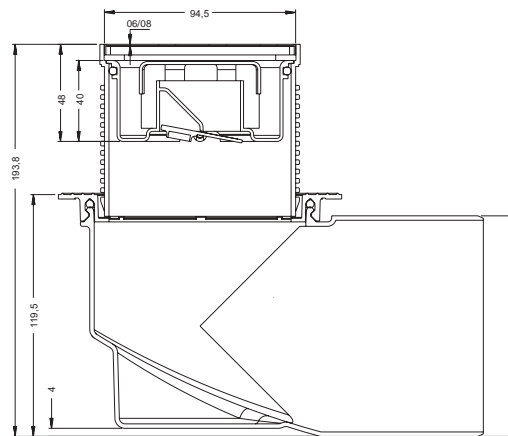
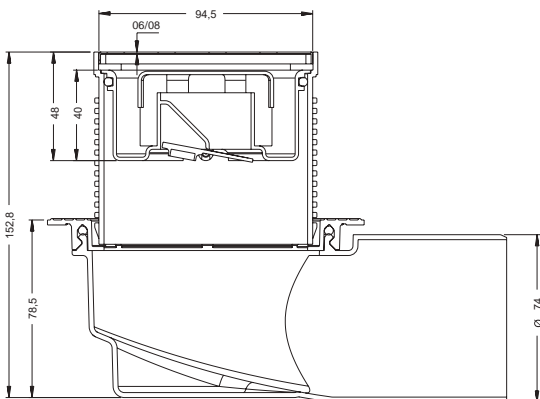
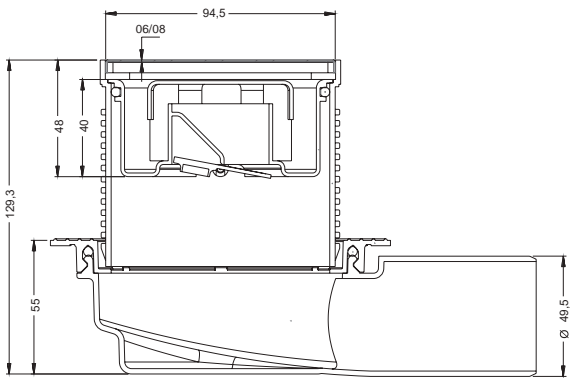
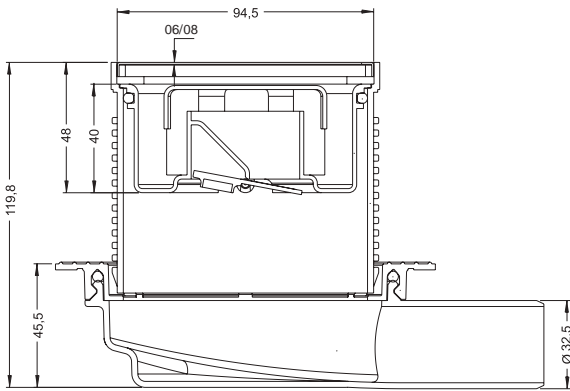

DN 50 side and vertical outlet - compatible with PVC pipe connections, blocking odor by water (36mm). The flow rate is 32 liters/min. Resistant against external chemical effects, operating temperature is between -30°C and +75°C. The grid is made of 304 grade stainless steel.

With its 304 grade stainless steel grid, it has a quality and stylish-looking. It can be easily applied at floor. With its odor blocking by water support, it prevents the bad smell coming from the installation. With its adjustable height legs, it can be adjusted depending on the screed concrete. High resistance against the organic and inorganic chemicals, resistant against most acidic and vertically aqueous oxidation.

Common use of bathroom shower, hospital and hotel shower areas, locker-room shower areas etc.

Grid patterns can be chosen in gold, bronze or other optional colors in accordance with your desire.

It is not recommended to use high-density cleaners for a long-time.

# INSULATION IN COMPLIANCE

h10

## 140 MM 10x10



Code Outlet Length  Price \$

5054.0Y032.10.1	Ø 32	10x10 cm	50	5,81
5054.0Y040.10.1	Ø 40	10x10 cm	50	5,86
5054.0Y050.10.1	Ø 50	10x10 cm	50	5,86
5054.0Y070.10.1	Ø 70	10x10 cm	50	6,13
5054.0Y100.10.1	Ø 100	10x10 cm	50	6,63

5054.0A040.10.1	Ø 40	10x10 cm	50	5,64
5054.0A050.10.1	Ø 50	10x10 cm	50	5,64
5054.0A070.10.1	Ø 70	10x10 cm	50	5,64
5054.0A100.10.1	Ø 100	10x10 cm	50	5,64

\*Plastic body / Stainless steel grid / Odor blocking by water  
\*пластичное тело / Нержавеющая щетка / Сухой Затвор

هيكل بلاستيكي / شبكة مقاومة للصدأ / حابس رائحة مائي بصمام

## 180 MM 10x10



Code Outlet Length  Price \$

5058.0Y032.10.1	Ø 32	10x10 cm	50	5,96
5058.0Y040.10.1	Ø 40	10x10 cm	50	6,03
5058.0Y050.10.1	Ø 50	10x10 cm	50	6,03
5058.0Y070.10.1	Ø 70	10x10 cm	50	6,28
5058.0Y100.10.1	Ø 100	10x10 cm	50	6,78

5058.0A040.10.1	Ø 40	10x10 cm	50	5,81
5058.0A050.10.1	Ø 50	10x10 cm	50	5,81
5058.0A070.10.1	Ø 70	10x10 cm	50	5,81
5058.0A100.10.1	Ø 100	10x10 cm	50	5,81

\*Plastic body / Stainless steel grid / Odor blocking by water  
\*пластичное тело / Нержавеющая щетка / Сухой Затвор

هيكل بلاستيكي / شبكة مقاومة للصدأ / حابس رائحة مائي بصمام

## 180 MM 15x15



Code Outlet Length  Price \$

5058.0Y032.15.1	Ø 32	15x15cm	50	7,73
5058.0Y040.15.1	Ø 40	15x15cm	50	7,79
5058.0Y050.15.1	Ø 50	15x15cm	50	7,79
5058.0Y070.15.1	Ø 70	15x15cm	50	8,26
5058.0Y100.15.1	Ø 100	15x15cm	50	8,56

5058.0A040.15.1	Ø 40	15x15cm	50	7,58
5058.0A050.15.1	Ø 50	15x15cm	50	7,58
5058.0A070.15.1	Ø 70	15x15cm	50	7,58
5058.0A100.15.1	Ø 100	15x15cm	50	7,58

\*Plastic body / Stainless steel grid / Odor blocking by water  
\*пластичное тело / Нержавеющая щетка / Сухой Затвор

هيكل بلاستيكي / شبكة مقاومة للصدأ / حابس رائحة مائي بصمام



# INSULATION IN COMPLIANCE

# h10

## 140 MM 10x10 MESH



Code Outlet Length  Price \$

5054.FY032.10.1	Ø 32	10x10 cm	50	6,26
5054.FY040.10.1	Ø 40	10x10 cm	50	6,28
5054.FY050.10.1	Ø 50	10x10 cm	50	6,28
5054.FY070.10.1	Ø 70	10x10 cm	50	6,59
5054.FY100.10.1	Ø 100	10x10 cm	50	7,04

5054.FA040.10.1	Ø 40	10x10 cm	50	6,08
5054.FA050.10.1	Ø 50	10x10 cm	50	6,08
5054.FA070.10.1	Ø 70	10x10 cm	50	6,08
5054.FA100.10.1	Ø 100	10x10 cm	50	6,08

\*Plastic body / Stainless steel grid / Odor blocking by water  
\*пластичное тело / Нержавеющая щетка / Сухой Затвор

هيكل بلاستيكي / شبكة مقاومة للصدأ / حابس رائحة مائي بصمام

## 180 MM 10x10 MESH



Code Outlet Length  Price \$

5058.FY032.10.1	Ø 32	10x10 cm	50	6,36
5058.FY040.10.1	Ø 40	10x10 cm	50	6,41
5058.FY050.10.1	Ø 50	10x10 cm	50	6,41
5058.FY070.10.1	Ø 70	10x10 cm	50	6,64
5058.FY100.10.1	Ø 100	10x10 cm	50	7,13

5058.FA040.10.1	Ø 40	10x10 cm	50	6,16
5058.FA050.10.1	Ø 50	10x10 cm	50	6,16
5058.FA070.10.1	Ø 70	10x10 cm	50	6,16
5058.FA100.10.1	Ø 100	10x10 cm	50	6,16

\*Plastic body / Stainless steel grid / Odor blocking by water  
\*пластичное тело / Нержавеющая щетка / Сухой Затвор

هيكل بلاستيكي / شبكة مقاومة للصدأ / حابس رائحة مائي بصمام

## 180 MM 15x15 MESH



Code Outlet Length  Price \$

5058.FY032.15.1	Ø 32	15x15cm	50	8,13
5058.FY040.15.1	Ø 40	15x15cm	50	8,18
5058.FY050.15.1	Ø 50	15x15cm	50	8,18
5058.FY070.15.1	Ø 70	15x15cm	50	8,46
5058.FY100.15.1	Ø 100	15x15cm	50	8,94

5058.FA040.00.0	Ø 40	15x15cm	50	7,98
5058.FA050.00.0	Ø 50	15x15cm	50	7,98
5058.FA070.00.0	Ø 70	15x15cm	50	7,98
5058.FA100.00.0	Ø 100	15x15cm	50	7,98

\*Plastic body / Stainless steel grid / Odor blocking by water  
\*пластичное тело / Нержавеющая щетка / Сухой Затвор

هيكل بلاستيكي / شبكة مقاومة للصدأ / حابس رائحة مائي بصمام

# INSULATION IN COMPLIANCE

# h10

## 140 MM 10x10 T.MEMBRANE



Code	Outlet	Length		Price \$
------	--------	--------	--	----------

5054.TY032.10.1	Ø 32	10x10 cm	50	6,81
5054.TY040.10.1	Ø 40	10x10 cm	50	6,88
5054.TY050.10.1	Ø 50	10x10 cm	50	6,88
5054.TY070.10.1	Ø 70	10x10 cm	50	7,13
5054.TY100.10.1	Ø 100	10x10 cm	50	7,63

5054.TA040.10.1	Ø 40	10x10 cm	50	6,66
5054.TA050.10.1	Ø 50	10x10 cm	50	6,66
5054.TA070.10.1	Ø 70	10x10 cm	50	6,66
5054.TA100.10.1	Ø 100	10x10 cm	50	6,66

\*Plastic body / Stainless steel grid / Odor blocking by water

\*пластичное тело / Нержавеющая щетка / Сухой Затвор

هيكل بلاستيكي / شبكة مقاومة للصدأ / حابس رائحة مائي بصمام

## 180 MM 10x10 T.MEMBRANE



Code	Outlet	Length		Price \$
------	--------	--------	--	----------

5058.TY032.10.1	Ø 32	10x10 cm	50	6,89
5058.TY040.10.1	Ø 40	10x10 cm	50	6,96
5058.TY050.10.1	Ø 50	10x10 cm	50	6,96
5058.TY070.10.1	Ø 70	10x10 cm	50	7,21
5058.TY100.10.1	Ø 100	10x10 cm	50	7,73

5058.TA040.10.1	Ø 40	10x10 cm	50	6,69
5058.TA050.10.1	Ø 50	10x10 cm	50	6,69
5058.TA070.10.1	Ø 70	10x10 cm	50	6,69
5058.TA100.10.1	Ø 100	10x10 cm	50	6,69

\*Plastic body / Stainless steel grid / Odor blocking by water

\*пластичное тело / Нержавеющая щетка / Сухой Затвор

هيكل بلاستيكي / شبكة مقاومة للصدأ / حابس رائحة مائي بصمام

## 180 MM 15x15 T.MEMBRANE



Code	Outlet	Length		Price \$
------	--------	--------	--	----------

5058.TY032.15.1	Ø 32	15x15cm	50	8,67
5058.TY040.15.1	Ø 40	15x15cm	50	8,72
5058.TY050.15.1	Ø 50	15x15cm	50	8,72
5058.TY070.15.1	Ø 70	15x15cm	50	8,99
5058.TY100.15.1	Ø 100	15x15cm	50	9,49

5058.TA040.15.1	Ø 40	15x15cm	50	8,51
5058.TA050.15.1	Ø 50	15x15cm	50	8,51
5058.TA070.15.1	Ø 70	15x15cm	50	8,51
5058.TA100.15.1	Ø 100	15x15cm	50	8,51

\*Plastic body / Stainless steel grid / Odor blocking by water

\*пластичное тело / Нержавеющая щетка / Сухой Затвор

هيكل بلاستيكي / شبكة مقاومة للصدأ / حابس رائحة مائي بصمام

# INSULATION IN COMPLIANCE

# h10

## 210 MM 10x10



Code Outlet Length Price \$

506I.MY032.10.1	Ø 32	10x10 cm	50	9,71
506I.MY040.10.1	Ø 40	10x10 cm	50	9,76
506I.MY050.10.1	Ø 50	10x10 cm	50	9,76
506I.MY070.10.1	Ø 70	10x10 cm	50	10,02
506I.MY100.10.1	Ø 100	10x10 cm	50	10,52

506I.MA040.10.1	Ø 40	10x10 cm	50	9,54
506I.MA050.10.1	Ø 50	10x10 cm	50	9,54
506I.MA070.10.1	Ø 70	10x10 cm	50	9,54
506I.MA100.10.1	Ø 100	10x10 cm	50	9,54

\*Plastic body / Stainless steel grid / Odor blocking by water  
\*пластичное тело / Нержавеющая щетка / Сухой Затвор

هيكل بلاستيكي / شبكة مقاومة للصدأ / حابس رائحة مائي بصمام

## 210 MM 15x15



Code Outlet Length Price \$

506I.MY032.15.1	Ø 32	15x15cm	50	11,52
506I.MY040.15.1	Ø 40	15x15cm	50	11,57
506I.MY050.15.1	Ø 50	15x15cm	50	11,57
506I.MY070.15.1	Ø 70	15x15cm	50	11,84
506I.MY100.15.1	Ø 100	15x15cm	50	12,34

506I.MA040.15.1	Ø 40	15x15cm	50	11,36
506I.MA050.15.1	Ø 50	15x15cm	50	11,36
506I.MA070.15.1	Ø 70	15x15cm	50	11,36
506I.MA100.15.1	Ø 100	15x15cm	50	11,36

\*Plastic body / Stainless steel grid / Odor blocking by water  
\*пластичное тело / Нержавеющая щетка / Сухой Затвор

هيكل بلاستيكي / شبكة مقاومة للصدأ / حابس رائحة مائي بصمام

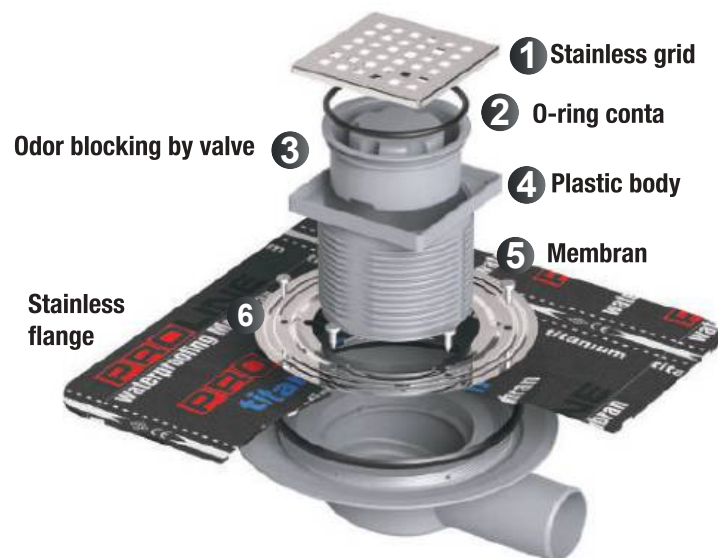

# INSULATION IN COMPLIANCE

h10

## PARAPET



## PARAPET



## ROOF VENTILATION



## PARAPHER INTERFACE



## LEAF HOLDER



Code

Diameter

Length



Price \$

8001.0Y070.00.0	Ø 70	-	35	2,27
8002.0Y100.00.0 парапете متراس	Ø 100	-	25	2,85

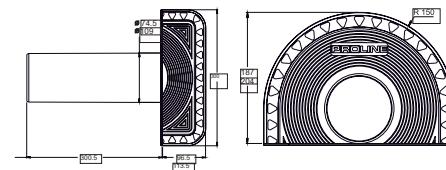

Code

Diameter

Length



Price \$

8001.0A070.00.0	Ø 70	-	35	2,27
8002.0A100.00.0 парапете - ВЕРТИКАЛЬНЫЙ СЛИВ هبوط عامودي	Ø 100	-	25	2,85

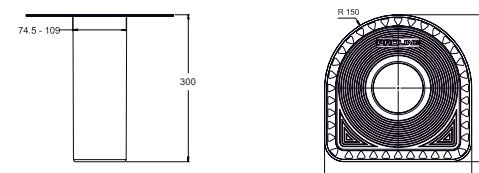

Code

Diameter

Length



Price \$

8003.0D070.00.0	Ø 70	-	35	1,38
8004.0D100.00.0 ПОТОЛОЧНЫЙ парапете سقف التهوية	Ø 100	-	35	1,53

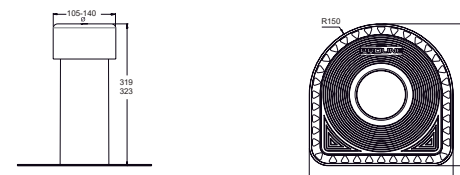

Code

Diameter

Length



Price \$

8201.0A070.10.0	Ø 70	-	35	0,63
8202.0A100.10.0 ПРОМЕЖУТОЧНЫЕ СОЕДИНЕНИЯ ТРАПА متراس موصل داخلي	Ø 100	-	35	0,63

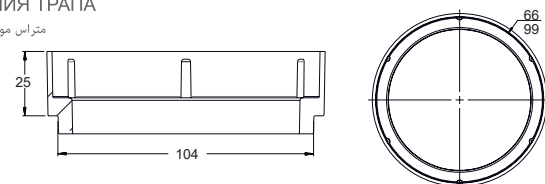

Code

Diameter

Length



Price \$

9302.0D100.00.0 ЛИСТОВАЯ СЕТКА لاقط أوراق	Ø 70-100	-	175	1,08
---	----------	---	-----	------

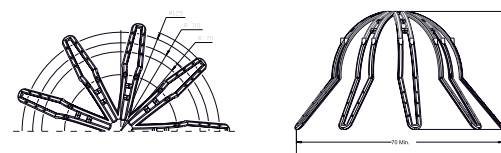

# INSULATION IN COMPLIANCE

h10

## PARAPET DOUBLE DRAINS 10x10



Code	Outlet	Length		Price \$
------	--------	--------	--	----------

8101.0Y070.10.1	Ø 70	10x10 cm	1	9,37
8101.0Y100.10.1	Ø 100	10x10 cm	1	10,08

ТРАП, МОНТИРУЕМЫЙ В ПОЛ  
مصاريف متراس مزدوجة

- 8001- Ø 70 Parapet + 5014.0Y050.10.1 Drain
- 8002- Ø 100 Parapet + 5014.0Y070.10.1 Drain

## PARAPET DOUBLE DRAINS 15x15



Code	Outlet	Length		Price \$
------	--------	--------	--	----------

8101.0Y070.15.1	Ø 70	15x15 cm	1	9,83
8101.0Y100.15.1	Ø 100	15x15 cm	1	10,67

ТРАП, МОНТИРУЕМЫЙ В ПОЛ  
مصاريف متراس مزدوجة

- 8001- Ø 70 Parapet + 5018.0Y050.15.1 Drain
- 8002- Ø 100 Parapet + 5018.0Y070.15.1 Drain

## VERTICAL DOUBLE DRAINS 10x10



Code	Diameter	Length		Price \$
------	----------	--------	--	----------

8102.0A070.10.1	Ø 70	10x10 cm	1	6,30
8102.0A100.10.1	Ø 100	10x10 cm	1	6,82

ДВОЙНОЙ ТРАП ВЕРТИКАЛЬНОГО СЛИВА  
مصاريف هبوط مزدوجة

- 8001- Ø 70 Parapet + 8201 Connection + 5101 Siphon Upper Body
- 8002- Ø 100 Parapet + 8202 Connection + 5101 Siphon Upper Body

## VERTICAL DOUBLE DRAINS 15x15



Code	Diameter	Length		Price \$
------	----------	--------	--	----------

8102.0A070.15.1	Ø 70	15x15 cm	1	8,10
8102.0A100.15.1	Ø 100	15x15 cm	1	8,57

ДВОЙНОЙ ТРАП ВЕРТИКАЛЬНОГО СЛИВА  
مصاريف هبوط مزدوجة

- 8001- Ø 70 Parapet + 8201 Connection + 5101 Siphon Upper Body
- 8002- Ø 100 Parapet + 8202 Connection + 5101 Siphon Upper Body

## SHINGLE VENTILATION

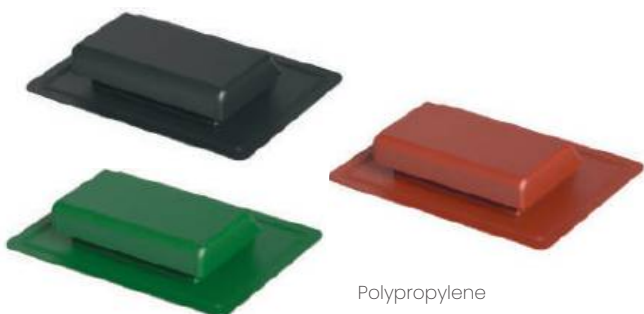

Polypropylene

Code	Length		Price \$
------	--------	--	----------

8010.YD080.00.S	34x44x8,5 cm	24	5,32
8010.YD080.00.Y	34x44x8,5 cm	24	5,32
8010.YD080.00.K	34x44x8,5 cm	24	5,32

## MODULAR RESERVATION SYSTEM

In wet areas, bathrooms and toilets often have acute leaks over time due to inadequate or poorly applied isolation work during construction, untreated capillary cracked concrete, insufficient workmanship, and lateral movements during use over time.

Leakage problems in wet spaces are a common question and it is troublesome and expensive to solve these problems during housing use. This system minimizes any problems that may occur in wet spaces and allows effortless intervention to the waste installation.

The recycling system is designed to ensure the smooth passage and continuity of the waste water pipes, the lines between the walls and floors, and to transport the leakage problems that may occur in the wet floors to the waste installation.

## SCOPE OF APPLICATION

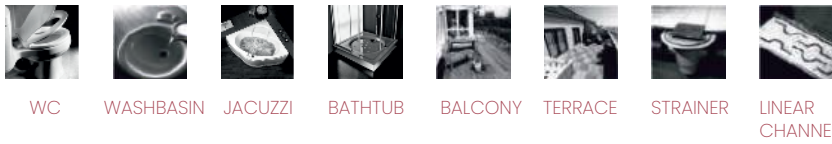

## RESERVATION ASSEMBLY DETAILS

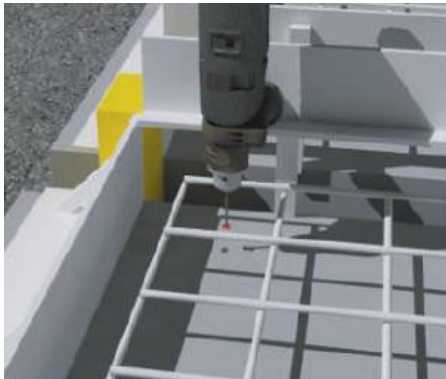

The points specified in the project in the tunnel mold system are drilled with M15 drill.

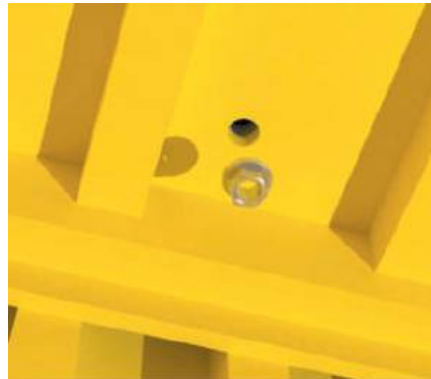

The thread nut is fixed to the center of the hole drilled in the lower part of the mold system. This process is done once only in the tunnel mold system.

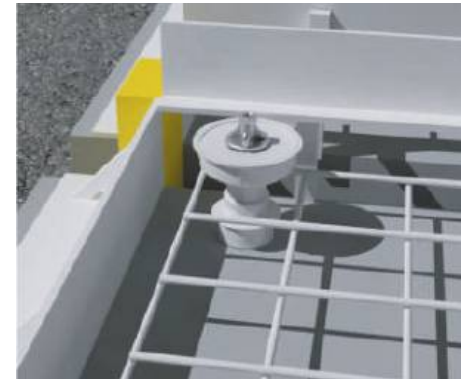

After the anchoring of the anchors, the parts of the reservation system are secured to the mold system by means of tie-rod. Concrete pouring process takes place and the system becomes ready for use.

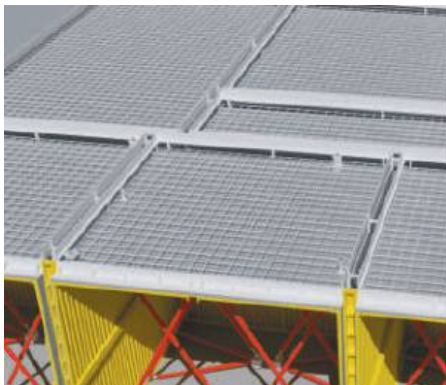

After the concrete casting takes place and the molds are removed, the expense line is ready for reuse. Installation can be done immediately.

## MODULAR RESERVATION SYSTEMS



CODE **0101001100050**  
 PRODUCT FLOOR ACCESS BOOKING  
 SIZE Ø 50 mm  
 PRICE \$ **1.85**



CODE **0103001100250**  
 PRODUCT FILTER  
 SIZE Ø 50 mm  
 PRICE \$ **1.47**



CODE **0104001000010**  
 PRODUCT FLOOR TRANSITION  
 SIZE Ø 50 mm  
 PRICE \$ **2.98**



CODE **0102001100100**  
 PRODUCT TRANSITIONAL RESERVATION  
 SIZE Ø 50 mm  
 PRICE \$ **2.37**



CODE **5107 A.Ç. Lire**  
 PRODUCT 15x15  
 NAME Floor drain  
 PRICE \$ **5.21**



CODE **5101 A.Ç. Lire**  
 PRODUCT 10x10  
 NAME Floor drain  
 PRICE \$ **3.45**



CODE **0120250103250**  
 PRODUCT TIE-ROT  
 NAME -  
 PRICE \$ **2.63**



CODE **0121000103251**  
 PRODUCT TIE-ROT SOMUN  
 NAME -  
 PRICE \$ **2.63**

## MODULAR RESERVATION SYSTEM SCHEMATIC SCREENING

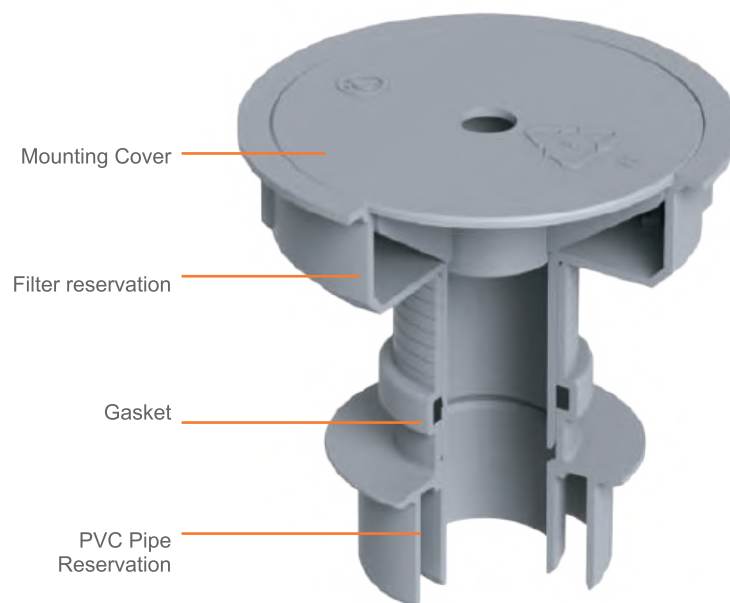

# SHOWER SET

NEW!

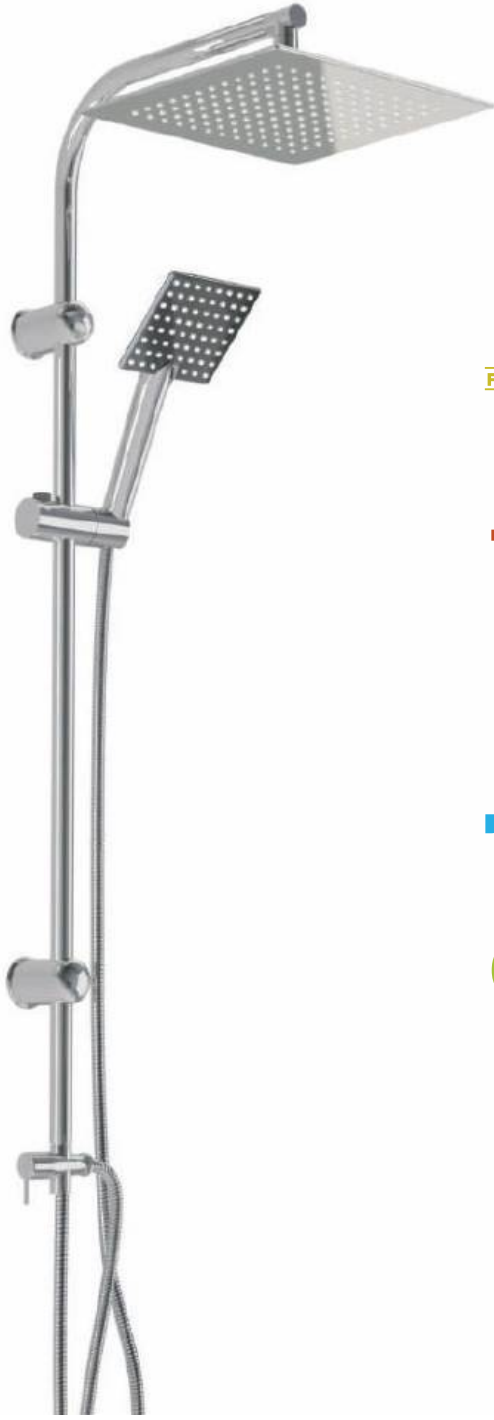

3  
FONKSİYON

mono  
FONKSİYON

SÜRGÜ  
DUŞ  
SİSTEMİ

DIRSEKLI  
DUŞ  
SİSTEMİ

60  
cm.

## ROBOT COSTA RICA

Code



Price \$

4970.01150.CR.3

8

93,40

22 mm diameter, stainless steel chrome plated "L" shape pipe. Shower heads are made of original ABS raw material. 250 mm overhead shower and 3-function special design hand shower. Water saving system. Lime crushing shower heads. ½" – ½" 150-165cm, double lock, stainless steel, EPDM hose, self-sealing, and brass connection ended spiral. Ergonomic crystal soap holder. Chrome plated plastic directing switch that can be used as a special mounting element. Adapters and installation parts compliant with all fittings. It provides excellent water flow at low water pressure. It provides up to 50% water saving. With its special directing switch, the transition between overhead shower and hand shower is very easy and it makes no leak. It is easy to install.

h10



3  
FONKSİYON

SÜRGÜ  
DUŞ  
SİSTEMİ

DIRSEKLI  
DUŞ  
SİSTEMİ

60  
cm.

## SLIDING COSTA RICA

Code



Price \$

4970.01150.CS.2

20

38,13

It is made of original ABS raw material. It is a 3-function shower head. It has lime crushing function. ½" – ½" 150-165 cm, double lock, stainless steel, EPDM hose, self-sealing, and brass connection ended spiral. 60-cm slide tube is made of stainless steel. It is easy to adjust height. Adapters and installation parts compliant with all fittings are included in the box. It provides excellent water flow at low water pressure. It provides up to 50% water saving.



mono  
FONKSİYON

DIRSEKLI  
DUŞ  
SİSTEMİ

## HANGER SET COSTA RICA

Code



Price \$

4970.01150.CM.1

28

19,45

It is made of original ABS raw material. It is a 3-function shower head. It has lime crushing function. ½" – ½" 150-165 cm, double lock, stainless steel, EPDM hose, self-sealing, and brass connection ended spiral. 60-cm slide tube is made of stainless steel. It is easy to adjust height. Adapters and installation parts compliant with all fittings are included in the box. It provides excellent water flow at low water pressure. It provides up to 50% water saving.



# SHOWER SET

h10

NEW!



3  
FONKSİYON

mono  
FONKSİYON

SÜRGÜ  
DUŞ  
SİSTEMİ

DIRSEKLI  
DUŞ  
SİSTEMİ

60  
cm.

## ROBOT VIYANA

Code



Price \$

4968.01150.VR.3

8

71,65

22 mm diameter, stainless steel chrome plated "L" shape pipe. Shower heads are made of original ABS raw material. 250 mm overhead shower and 3-function special design hand shower. Water saving system. Lime crushing shower heads. ½" – ½" 150-165cm, double lock, stainless steel, EPDM hose, self-sealing, and brass connection ended spiral. Ergonomic crystal soap holder. Chrome plated plastic directing switch that can be used as a special mounting element. Adapters and installation parts compliant with all fittings. It provides excellent water flow at low water pressure. It provides up to 50% water saving. With its special directing switch, the transition between overhead shower and hand shower is very easy and it makes no leak. It is easy to install.



3  
FONKSİYON

SÜRGÜ  
DUŞ  
SİSTEMİ

DIRSEKLI  
DUŞ  
SİSTEMİ

60  
cm.

## SLIDING VIYANA

Code



Price \$

4968.01150.VS.2

20

22,53

It is made of original ABS raw material. It is a 3-function shower head. It has lime crushing function. ½" – ½" 150-165 cm, double lock, stainless steel, EPDM hose, self-sealing, and brass connection ended spiral. 60-cm slide tube is made of stainless steel. It is easy to adjust height. Adapters and installation parts compliant with all fittings are included in the box. It provides excellent water flow at low water pressure. It provides up to 50% water saving.



mono  
FONKSİYON

DIRSEKLI  
DUŞ  
SİSTEMİ

## HANGER SET VIYANA

Code



Price \$

4968.01150.VM.1

28

12,28

It is made of original ABS raw material. It is a 3-function shower head. It has lime crushing function. ½" – ½" 150-165 cm, double lock, stainless steel, EPDM hose, self-sealing, and brass connection ended spiral. 60-cm slide tube is made of stainless steel. It is easy to adjust height. Adapters and installation parts compliant with all fittings are included in the box. It provides excellent water flow at low water pressure. It provides up to 50% water saving.

# SHOWER SET

NEW!



3  
FONKSİYON

mono  
FONKSİYON

SÜRGÜ  
DÜŞ  
SİSTEMİ

DİRSEKLI  
DÜŞ  
SİSTEMİ

60  
cm.

## ROBOT NAPOLI

Code



Price \$

4967.01150.PR.3

8

71,65

22 mm diameter, stainless steel chrome plated "L" shape pipe. Shower heads are made of original ABS raw material. 250 mm overhead shower and 3-function special design hand shower. Water saving system. Lime crushing shower heads. ½" – ½" 150-165cm, double lock, stainless steel, EPDM hose, self-sealing, and brass connection ended spiral. Ergonomic crystal soap holder. Chrome plated plastic directing switch that can be used as a special mounting element. Adapters and installation parts compliant with all fittings. It provides excellent water flow at low water pressure. It provides up to 50% water saving. With its special directing switch, the transition between overhead shower and hand shower is very easy and it makes no leak. It is easy to install.

h10



3  
FONKSİYON

SÜRGÜ  
DÜŞ  
SİSTEMİ

DİRSEKLI  
DÜŞ  
SİSTEMİ

60  
cm.

## SLIDING NAPOLI

Code



Price \$

4967.01150.PS.2

20

24,57

It is made of original ABS raw material. It is a 3-function shower head. It has lime crushing function. ½" – ½" 150-165 cm, double lock, stainless steel, EPDM hose, self-sealing, and brass connection ended spiral. 60-cm slide tube is made of stainless steel. It is easy to adjust height. Adapters and installation parts compliant with all fittings are included in the box. It provides excellent water flow at low water pressure. It provides up to 50% water saving.



mono  
FONKSİYON

DİRSEKLI  
DÜŞ  
SİSTEMİ

## HANGER SET NAPOLI

Code



Price \$

4967.01150.PM.1

28

14,33

It is made of original ABS raw material. It is a 3-function shower head. It has lime crushing function. ½" – ½" 150-165 cm, double lock, stainless steel, EPDM hose, self-sealing, and brass connection ended spiral. 60-cm slide tube is made of stainless steel. It is easy to adjust height. Adapters and installation parts compliant with all fittings are included in the box. It provides excellent water flow at low water pressure. It provides up to 50% water saving.

# SHOWER SET

NEW!



60  
cm.

## ROBOT CUBA

Code



Price \$

4969.01160.CR.3

1

93,40

22 mm diameter, stainless steel chrome plated "L" shape pipe. Shower heads are made of original ABS raw material. 250 mm overhead shower and 3-function special design hand shower. Water saving system. Lime crushing shower heads. ½" – ½" 150-165cm, double lock, stainless steel, EPDM hose, self-sealing, and brass connection ended spiral. Ergonomic crystal soap holder. Chrome plated plastic directing switch that can be used as a special mounting element. Adapters and installation parts compliant with all fittings. It provides excellent water flow at low water pressure. It provides up to 50% water saving. With its special directing switch, the transition between overhead shower and hand shower is very easy and it makes no leak. It is easy to install.

h10



60  
cm.

## SLIDING CUBA

Code



Price \$

4969.01160.CS.2

1

40,18

It is made of original ABS raw material. It is a 3-function shower head. It has lime crushing function. ½" – ½" 150-165 cm, double lock, stainless steel, EPDM hose, self-sealing, and brass connection ended spiral. 60-cm slide tube is made of stainless steel. It is easy to adjust height. Adapters and installation parts compliant with all fittings are included in the box. It provides excellent water flow at low water pressure. It provides up to 50% water saving.



## HANGER SET CUBA

Code



Price \$

4969.01160.CM.1

1

21,50

It is made of original ABS raw material. It is a 3-function shower head. It has lime crushing function. ½" – ½" 150-165 cm, double lock, stainless steel, EPDM hose, self-sealing, and brass connection ended spiral. 60-cm slide tube is made of stainless steel. It is easy to adjust height. Adapters and installation parts compliant with all fittings are included in the box. It provides excellent water flow at low water pressure. It provides up to 50% water saving.

# SHOWER PANEL SET

h10

NEW!



PANEL SHOWER GÖKSU

Code		Price \$
4565.01150GP4	1	281,48

NEW!



PANEL SHOWER ARDA

Code		Price \$
4965.01150AP5	1	281,48

# SHOWER PANEL SET

h10

NEW!



PANEL SHOWER MERİÇ

Code		Price \$
4965.01150MP1	1	391,15

NEW!



PANEL SHOWER ILGAZ

Code		Price \$
4965.01150IP6	1	391,15

# SHOWER PANEL SET

h10

NEW!



PANEL SHOWER ARAS

Code		Price \$
4965.01150AP3	1	391,15

NEW!



PANEL SHOWER CEYHAN

Code		Price \$
4965.01150CP2	1	318,08

# POOL SHOWER SET

h10

NEW!



POOL SHOWER PANEL ELA

Code		Price \$
4964.01150HE.1	1	1333,00

NEW!



POOL SHOWER PANEL IŞIL

Code		Price \$
4964.01150HI.2	1	1200,00

# DRAINAGE CHANNELS

h10



Plastic body



Plastic Grid



Stainless grid



Plastic Cap

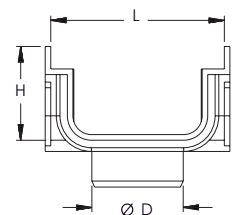
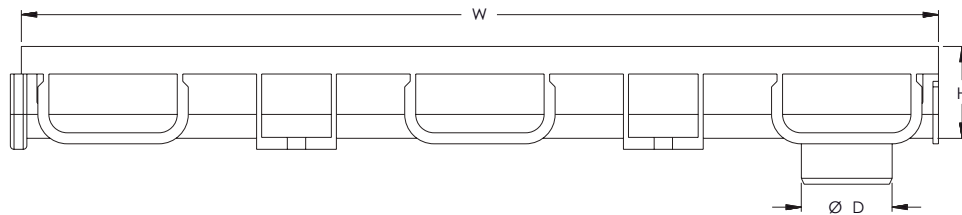
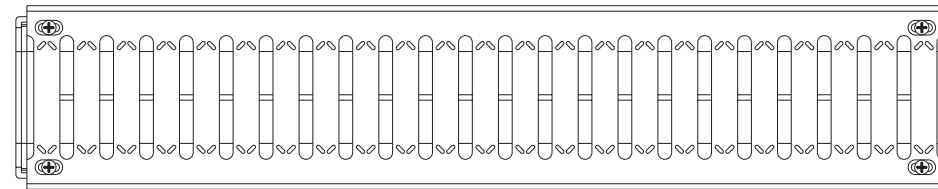
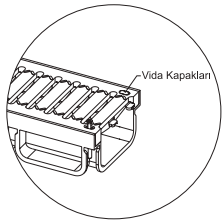
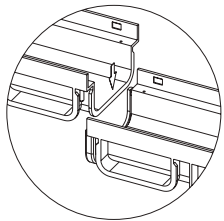
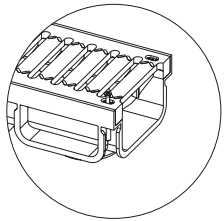

## CHANNEL 100x500 mm

Code	Length	Length		Price \$
7010.05005Y0.0	100x500 mm	50 mm	40	2,23
7010.05005A.0.0	100x500 mm A.Ç.	50 mm	32	2,27

канал / القناة

## PLASTIC GRID100x500mm

Code	Length	Length		Price \$
7110.050120.0.0	100x500 mm	-	40	1,78

Решетка / الشبكة

## STAINLESS GRID100x500mm

Code	Length	Quality	Pattern	Price \$
2110.05012P304.1	100x500 mm	S.S.304	FISH	12,23
2110.05012P304.2	100x500 mm	S.S.304	SQUARE	12,23
2110.10012P304.1	100x1000 mm	S.S.304	FISH	24,45
2110.10012P304.2	100x1000 mm	S.S.304	SQUARE	24,45

Решетка / الشبكة

2110.05012G.430.1	100x500 mm	Galvanized	SQUARE	4,03
2110.05012G.430.2	100x1000 mm	Galvanized	SQUARE	8,07

## CAP 100 mm

Code	Length	Length		Price \$
7210.00050Y0.0	80x63 mm	-	150	0,57

Заглушка / سدادة

## GRILL PATTERN OPTIONS



PLASTIC

• PP



FISH

• AISI 304  
• AISI 430  
• Galvanized



SQUARE

• AISI 304  
• AISI 430  
• Galvanized



# DRAINAGE CHANNELS

h10



Plastic body

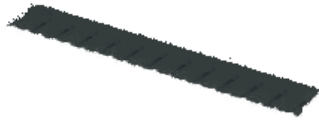

Plastic Grid

Stainless grid

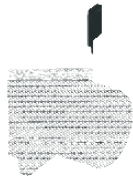

Plastic Cap

## CHANNEL 100x500 mm

Code	Length	Length		Price \$
7010.05005Y0.S	100x500 mm	50 mm	40	1,92
7010.05005A.0.S	100x500 mm A.Ç.	50 mm	32	1,95

канал / القناة

## PLASTIC GRID 100x500mm

Code	Length	Length		Price \$
7110.050120.0.S	100x500 mm	-	40	1,58

Решетка / الشبكة

## STAINLESS GRID 100x500mm

Code	Length	Quality	Pattern	Price \$
2110.05012P304.1	100x500 mm	S.S.304	FISH	12,23
2110.05012P304.2	100x500 mm	S.S.304	SQUARE	12,23
2110.10012P304.1	100x1000 mm	S.S.304	FISH	24,45
2110.10012P304.2	100x1000 mm	S.S.304	SQUARE	24,45
2110.05012G.430.1	100x500 mm	Galvanized	SQUARE	4,03
2110.05012G.430.2	100x1000 mm	Galvanized	SQUARE	8,07

Решетка / الشبكة

## CAP 100 mm

Code	Length	Length		Price \$
7210.000050Y0.S	80x63 mm	-	150	0,57

Заглушка / سداة

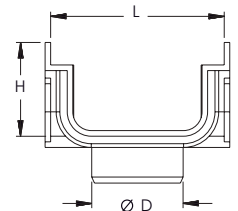
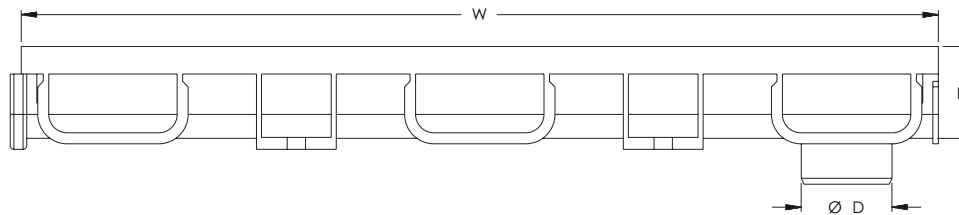
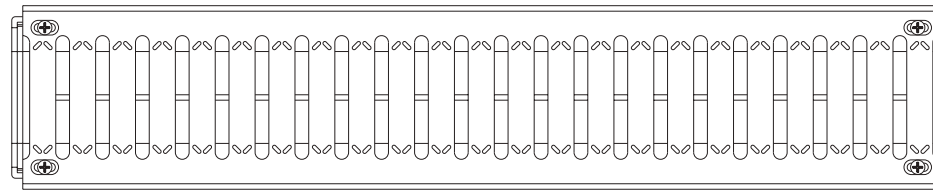
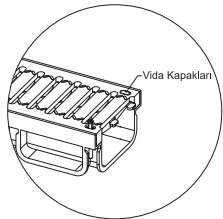
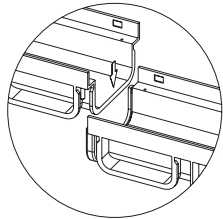
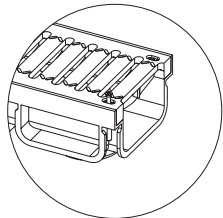

## GRILL PATTERN OPTIONS



- PP
- AISI 304
- AISI 430
- Galvanized
- Cast Iron

PLASTIC



- AISI 304
- AISI 430
- Galvanized

FISH



- AISI 304
- AISI 430
- Galvanized

SQUARE

# DRAINAGE CHANNELS

h10



Polypropylene



Polypropylene



Stainless



7212.00070Y.0.0



7212.00070Y.0.0



7212.00070Y.0.0

Polypropylene

## CHANNEL 130x500 mm

Code	Length	Length	Outlet		Price \$
7013.05008Y.0.0	130x500 mm	75 mm	-	40	2,73
7014.05008A.0.0	130x500 mm A.Ç.	75 mm	Ø 49.5 / 74.5	32	2,78

канал / القناة

## PLASTIC GRID130x500mm

Code	Length	Length		Price \$
7113.050200.0.0	130x500 mm	-	40	2,50

Решетка / الشبكة

## STAINLESS GRID130x500mm

Code	Length	Quality	Pattern	Price \$
2113.05020P304.1	130x500 mm	S.S.304	FISH	15,83
2113.05020P304.2	130x500 mm	S.S.304	SQUARE	15,83
2113.05020P304.4	130x500 mm	S.S.304	STANDARD	13,33
2113.05020P304.5	130x500 mm	S.S.304	ROUND	15,83
2113.10020P304.1	130x1000 mm	S.S.304	FISH	31,12
2113.10020P304.2	130x1000 mm	S.S.304	SQUARE	31,12
2113.10020P304.4	130x1000 mm	S.S.304	STANDARD	26,12
2113.10020P304.5	130x1000 mm	S.S.304	ROUND	31,12
2113.05020P430.4	130x500 mm	Galvanized	STANDARD	5,37
2113.10021P430.4	130x1000 mm	Galvanized	STANDARD	8,33
2113.05020P430.1	130x500 mm	Galvanized	ROUND	5,37

Решетка / الشبكة

## GRID 130x500mm

Code	Length	Quality	Pattern	Price \$
2113.05020D.000.4	130x500 mm	Cast Iron	STANDARD	21,60

Решетка / الشبكة

## CAP 130 mm

Code	Length		Price \$
7212.00070Y.0.0	125x75 mm	150	0,60
7227.00070Y.0.0	125x75 mm	150	0,60
7228.00070Y.0.0	125x75 mm	150	0,60



# DRAINAGE CHANNELS

h10



Polypropylene

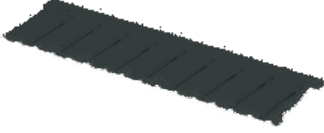

Polypropylene



7212.00070Y.0.0

7212.00070Y.0.0

7212.00070Y.0.0

Polypropylene

## CHANNEL 130x500 mm

Code	Length	Length	Outlet		Price \$
7013.05008Y.0.S	130x500 mm	75 mm	-	40	2,27
7014.05008A.0.S	130x500 mm A.Ç.	75 mm	Ø 49.5 / 74.5	32	2,28

канал / القناة

## PLASTIC GRID 130x500mm

Code	Length	Length		Price \$
7113.050200.0.S	130x500 mm	-	40	2,07

Решетка / الشبكة

## CAP 130 mm

Code	Length		Price \$
7212.00070Y.0.S	125x75 mm	150	0,95
7227.00070Y.0.S	125x75 mm	150	0,95
7228.00070Y.0.S	125x75 mm	150	0,95

Заглушка / سداة

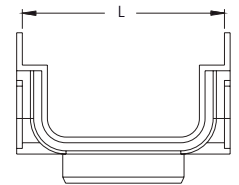
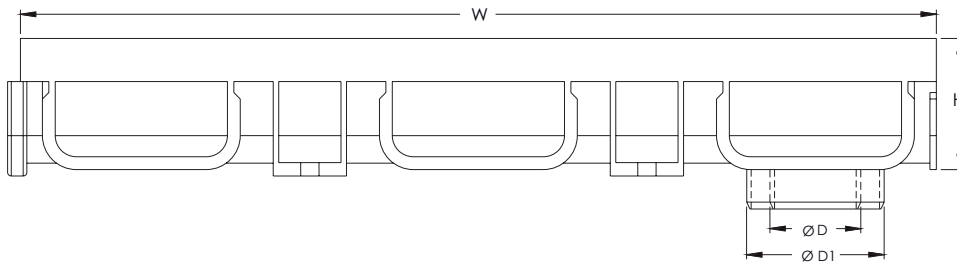
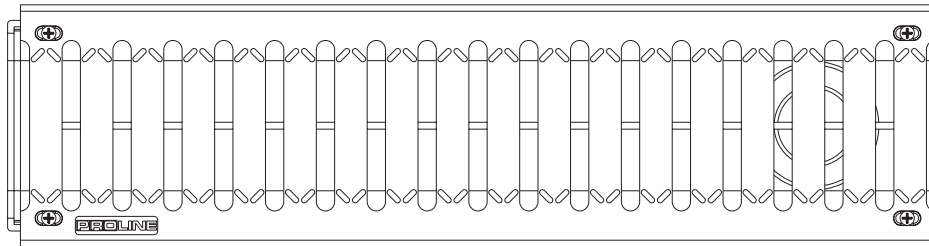
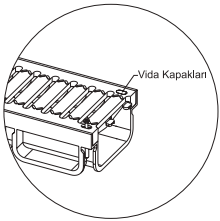
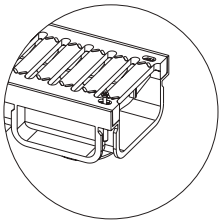

Code	W	L	H	Ø D	Ø D1
	500	125	75	-	-
7014.05008A.0.0	500	125	75	49.5	74.5



# DRAINAGE CHANNELS

h10



## CHANNEL 130x1000 mm

Code	Length	Length	Outlet		Price \$
7015.10010Y.0.0	130x1000 mm	100 mm	-	20	6,38
7016.10010A.0.0	130x1000mmA.Ç.	100 mm	Ø 49.5 / 74.5	16	6,45

канал / القناة



Polypropylene

## PLASTIC GRID130x500mm

Code	Length		Price \$
7113.050200.0.0	130x500 mm	40	2,50

Решетка / الشبكة

Polypropylene



7213.00100Y.0.0

7230.00100Y.0.0

7231.00100Y.0.0

Polypropylene

## CAP 130 mm

Code	Length		Price \$
7213.00100Y.0.0	125x100 mm	150	1,08
7230.00100Y.0.0	125x100 mm	150	1,08
7231.00100Y.0.0	125x100 mm	150	1,08

Заглушка / سداة

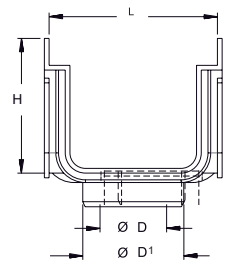
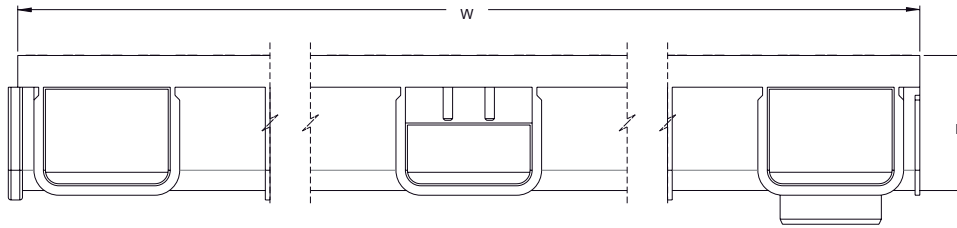
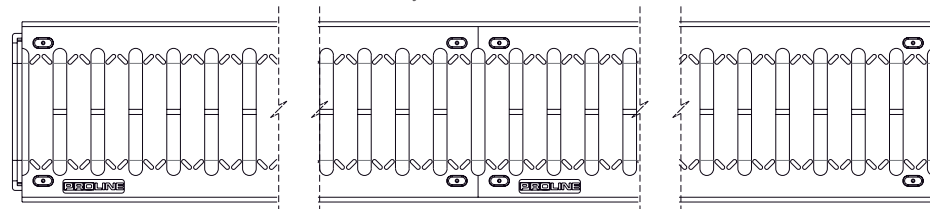
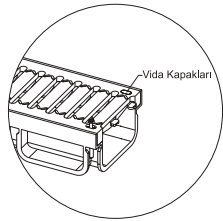
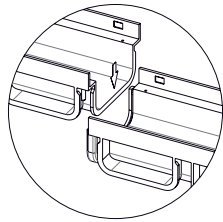
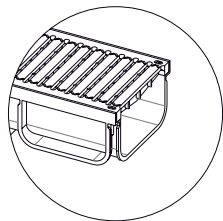

## GRILL PATTERN OPTIONS



PLASTIC

• PP



FISH

• AISI 304  
• AISI 430  
• Galvanized



SQUARE

• AISI 304  
• AISI 430  
• Galvanized



ROUND

• AISI 304  
• AISI 430  
• Galvanized

Code	W	L	H	Ø D	Ø D1
7016.10010A.0.0	1000	125	75	-	-
	1000	125	75	49.5	74.5



# DRAINAGE CHANNELS

h10



## CHANNEL 130x1000 mm

Code	Length	Length	Outlet		Price \$
7015.10010Y.0.S	130x1000 mm	100 mm	-	20	5,20
7016.10010A.0.S	130x1000mmA.Ç.	100 mm	Ø 49.5 / 74.5	16	5,25

канал / القناة

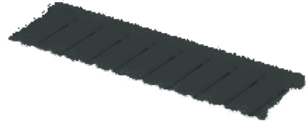

Polypropylene

## PLASTIC GRID 130x500mm

Code	Length		Price \$
7113.050200.0.S	130x500 mm	40	2,07

Решетка / الشبكة



7213.00100Y.0.0

7230.00100Y.0.0

7231.00100Y.0.0

Polypropylene

## CAP 130 mm

Code	Length		Price \$
7213.00100Y.0.S	125x100 mm	150	1,05
7230.00100Y.0.S	125x100 mm	150	1,05
7231.00100Y.0.S	125x100 mm	150	1,05

Заглушка / سداة

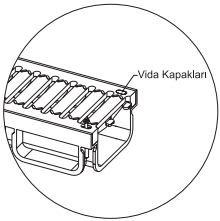
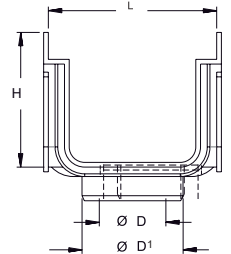
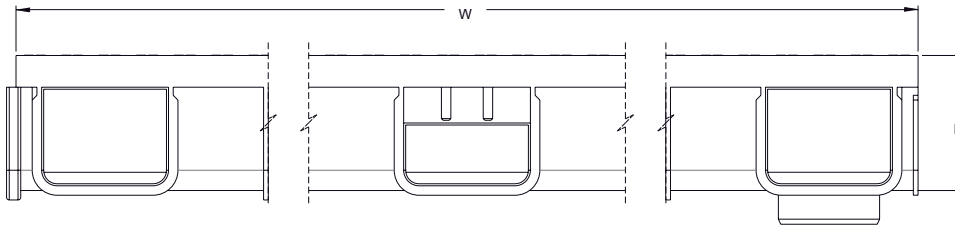
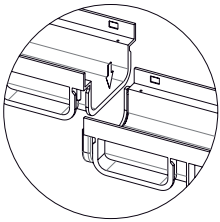
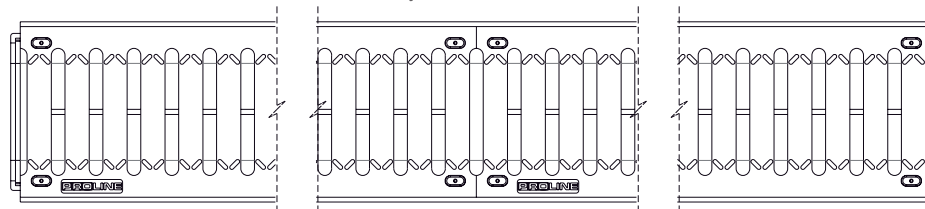
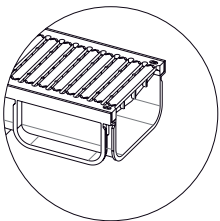

Vida Kapakları

## GRILL PATTERN OPTIONS



• PP

PLASTIC



• AISI 304  
• AISI 430  
• Galvanized

FISH



• AISI 304  
• AISI 430  
• Galvanized

SQUARE



• AISI 304  
• AISI 430  
• Galvanized

ROUND

Code	W	L	H	Ø D	Ø D1
7016.10010A.0.0	1000	125	75	-	-
	1000	125	75	49.5	74.5



# DRAINAGE CHANNELS

h10



## CHANNEL 200x500 mm

Code	Length	Length	Outlet		Price \$
7020.05013Y0.0	200x500 mm	120 mm	-	20	4,78
7021.05013A.0.0	200x500 mm A.Ç.	120 mm	Ø 74.5 / 109.5	18	4,93

канал / القناة



Polypropylene

## PLASTIC GRID 200x500 mm

Code	Length	Length		Price \$
7120.050200.0.0	200x500 mm	-	20	3,93

Решетка / الشبكة



Polypropylene

## STAINLESS GRID 200x500mm

Code	Length	Quality	Pattern	Price \$
2120.05021P304.2	200x500 mm	S.S.304	SQUARE	27,78
2120.05021P304.3	200x500 mm	S.S.304	LINE	27,78
2120.05021P304.4	200x500 mm	S.S.304	STANDARD	26,67
2120.05021P304.5	200x500 mm	S.S.304	ROUND	27,78
2120.05021P430.4	200x500 mm	GALVANIZ	STANDARD	10,57

Заглушка / سداة



GRID

## GRID 200x500mm

Code	Length	Quality	Pattern	Price \$
2120.05020D.000.4	200x500 mm	Cast Iron	STANDARD	36,00

Заглушка / سداة

## CAP 200 mm

Code	Length	Length		Price \$
7220.00120Y.0.0	200x500 mm	-	150	1,10

Заглушка / سداة



Polypropylene

## GRILL PATTERN OPTIONS



• PP

PLASTIC



• AISI 304  
• AISI 430  
• Galvanized

SQUARE



• AISI 304  
• AISI 430  
• Galvanized

ROUND

Code	W	L	H	Ø D	Ø D1
	500	200	120	-	-
7021.05013A.0.0	500	200	120	74.5	109.5

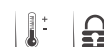

# DRAINAGE CHANNELS

h10



## CHANNEL 200x500 mm

Code	Length	Length	Outlet		Price \$
7020.05013Y.0.S	200x500 mm	120 mm	-	20	3,87
7021.05013A.0.S	200x500 mm A.Ç.	120 mm	Ø 74.5 / 109.5	18	3,98

канал / القناة

## PLASTIC GRID 200x500 mm

Code	Length	Length		Price \$
7120.050200.0.S	200x500 mm	-	20	3,15

Решетка / الشبكة

## CAP 200 mm

Code	Length	Length		Price \$
7220.00120Y.0.S	200x500 mm	-	150	1,02

Заглушка / سداة



Polypropylene

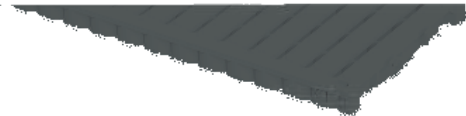

Polypropylene



Polypropylene

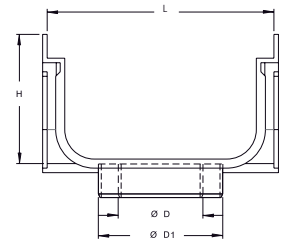
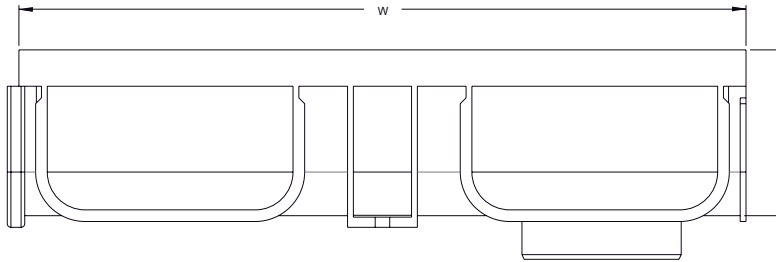
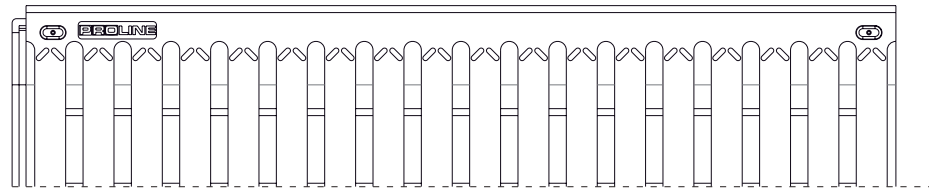
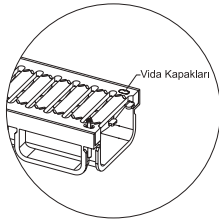
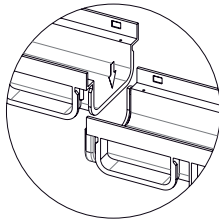
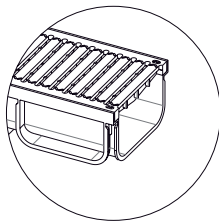

## GRILL PATTERN OPTIONS



PLASTIC

• PP



SQUARE

• AISI 304  
• AISI 430  
• Galvanized



ROUND

• AISI 304  
• AISI 430  
• Galvanized

Code	W	L	H	Ø D	Ø D1
7021.05013A.0.0	500	200	120	-	-
	500	200	120	74.5	109.5



# DRAINAGE CHANNELS

h10



Polymer



Polymer



## POLYMER CHANNEL 100x1000 mm

Code	Length	Length		Price \$
2010.100K00.060.S	1000x1000 mm	60 mm	-	31,83
2010.100K00.080.S	1000x1000 mm	80 mm	-	33,70

канал / القناة

## GRID 100 mm

Code	Length	Quality	Pattern	Price \$
2110.05012P304.1	100x500 mm	SS.304	FISH	12,23
2110.05012P304.2	100x500 mm	SS.304	SQUARE	24,45
2110.10012P304.1	100x1000 mm	SS.304	FISH	24,45
2110.10012P304.2	100x1000 mm	SS.304	SQUARE	24,45
2110.05012G.430.1	100x500 mm	Galva-	SQUARE	4,03
2110.05012G.430.2	100x1000 mm	nized	SQUARE	8,07
		Galva-		
		nized		

канал / القناة

## CAP 100 mm

Code	Length	Length		Price \$
2010.000T00.060.S	100x60 mm	60 mm	-	4,68
2010.000T00.080.S	100x80 mm	80 mm	-	4,68

канал / القناة

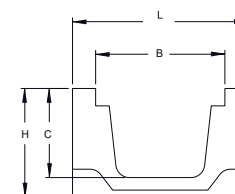
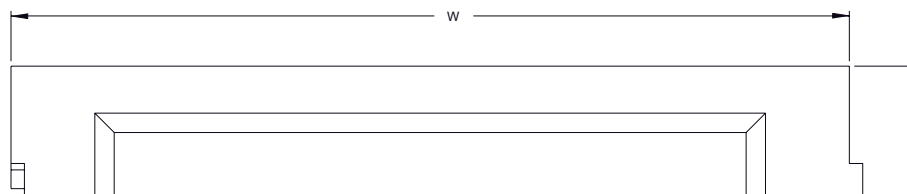
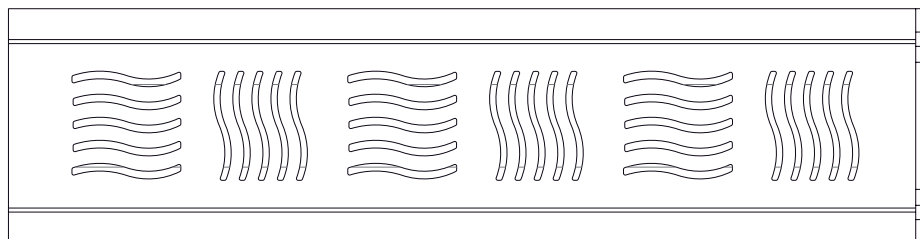
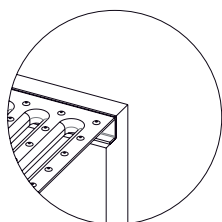

## GRILL PATTERN OPTIONS



- AISI 304
- AISI 430
- Galvanized

FISH



- AISI 304
- AISI 430
- Galvanized

SQUARE

Code	W	L	H	Ø D	Ø D1
7021.05013A.0.0	500	200	120	-	-
	500	200	120	74.5	109.5





# DRAINAGE CHANNELS

h10



Polymer



Polymer



Polymer

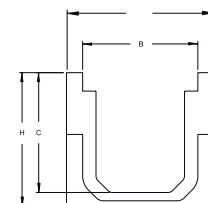
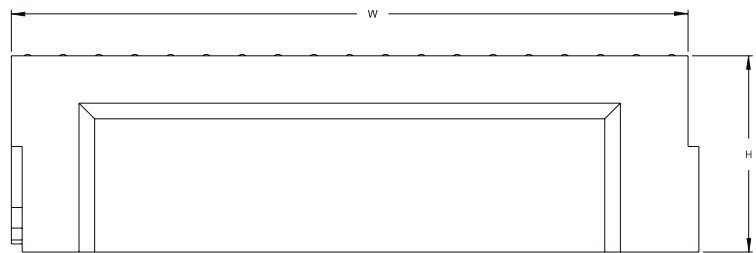
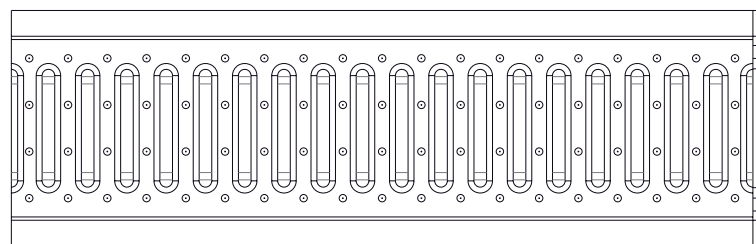
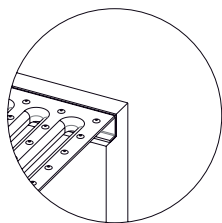

## POLYMER CHANNEL 130x1000 mm

Code	Length	Length		Price \$
2013.100K00.060.S	130x1000 mm	60 mm	-	38,38
2013.100K00.080.S	130x1000 mm	80 mm	-	40,25
2013.100K00.100.S	130x1000 mm	100 mm	-	43,07
2013.100K00.150.S	130x1000 mm	150 mm	-	46,80
2013.100K00.200.S	130x1000 mm	200 mm	-	56,17

канал / القناة

## FRAMED POLYMER CHANNEL 130x1000 mm

Code	Length	Length		Price \$
2013.100K00.060.Ç	130x1000 mm	60 mm	-	44,00
2013.100K00.080.Ç	130x1000 mm	80 mm	-	46,80
2013.100K00.100.Ç	130x1000 mm	100 mm	-	51,48
2013.100K00.150.Ç	130x1000 mm	150 mm	-	59,92

канал / القناة

## CAP 130 mm

Code	Length	Length		Price \$
2013.000T00.060.S	130x60 mm	60 mm	-	4,68
2013.000T00.080.S	130x80 mm	80 mm	-	4,68
2013.000T00.100.S	130x100 mm	100 mm	-	4,68
2013.000T00.150.S	130x150 mm	150 mm	-	4,68
2013.000T00.200.S	130x200 mm	200 mm	-	6,57

канал / القناة

## GRILL PATTERN OPTIONS



PLASTIC

- PP
- AISI 304
- AISI 430
- Galvanized
- Cast Iron



FISH

- AISI 304
- AISI 430
- Galvanized



SQUARE

- AISI 304
- AISI 430
- Galvanized



ROUND

- AISI 304
- AISI 430
- Galvanized

Code	W	L	H	C	B
2013.100K00.080.S	1000	160	75	60	130
2013.100K00.150.S	1000	160	115	100	130
	1000	160	165	150	130
	1000	160	215	200	130

# GRID

# h10

## GRID 130 mm



Code	Length	Quality	Pattern	Price \$
2113.05020P304.1	130x500 mm	SS.304	FISH	15,83
2113.05020P304.2	130x500 mm	SS.304	SQUARE	15,83
2113.05020P304.4	130x500 mm	SS.304	STANDARD	13,33
2113.05020P304.5	130x500 mm	SS.304	ROUND	15,83
2113.10020P304.1	130x1000 mm	SS.304	FISH	31,12
2113.10020P304.2	130x1000 mm	SS.304	SQUARE	31,12
2113.10020P304.4	130x1000 mm	SS.304	STANDARD	26,12
2113.10020P304.5	130x1000 mm	SS.304	ROUND	31,12
2113.05020P430.4	130x500 mm	Galvanized	STANDARD	5,37
2113.10020P430.4	130x1000 mm	Galvanized	STANDARD	8,33
2113.05020P430.1	130x500 mm	Galvanized	ROUND	5,37

канал / القناة

## GRID 130 mm



Code	Length	Quality	Pattern	Price \$
2113.05020D.000.4	130x500 mm	Cast Iron	STANDARD	21,60

канал / القناة

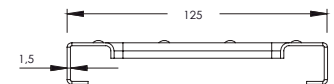
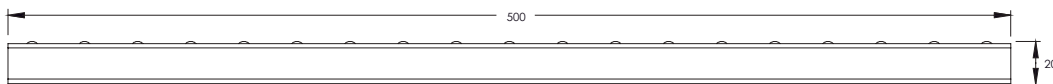
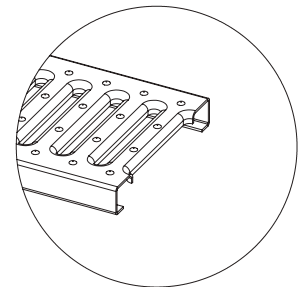
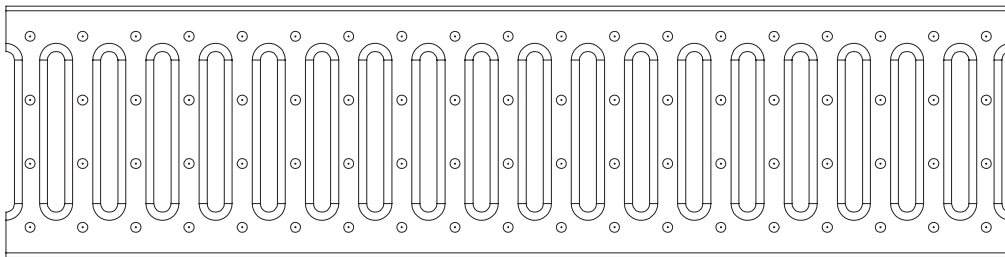

# DRAINAGE CHANNELS

h10



Polymer



Polymer



Polymer

## POLYMER CHANNEL 200x1000 mm

Code	Length	Length		Price \$
2020.100K00.060.S	200x1000 mm	60 mm	-	42,13
2020.100K00.080.S	200x1000 mm	80 mm	-	44,93
2020.100K00.120.S	200x1000 mm	120 mm	-	49,62
2020.100K00.150.S	200x1000 mm	150 mm	-	54,30
2020.100K00.200.S	200x1000 mm	200 mm	-	62,72
2020.100K00.250.S	200x1000 mm	250 mm	-	70,20

канал / القناة

## FRAMED POLYMER CHANNEL 200x1000 mm

Code	Length	Length		Price \$
2020.100K00.060.Ç	200x1000 mm	60 mm	-	49,62
2020.100K00.080.Ç	200x1000 mm	80 mm	-	54,30
2020.100K00.120.Ç	200x1000 mm	120 mm	-	63,65
2020.100K00.150.Ç	200x1000 mm	150 mm	-	68,33
2020.100K00.200.Ç	200x1000 mm	200 mm	-	73,95
2020.100K00.300.Ç	200x1000 mm	300 mm	-	98,28
2020.100K00.400.Ç	200x1000 mm	400 mm	-	117,00

канал / القناة

## CAP 200 mm

Code	Length	Length		Price \$
2020.000T00.060.S	200x60 mm	60 mm	-	5,62
2020.000T00.080.S	200x80 mm	80 mm	-	5,62
2020.000T00.120.S	200x120 mm	120 mm	-	7,50
2020.000T00.150.S	200x150 mm	150 mm	-	7,50
2020.000T00.200.S	200x200 mm	200 mm	-	7,50
2020.000T00.300.S	200x300 mm	300 mm	-	9,37

канал / القناة

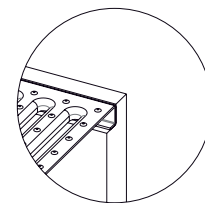
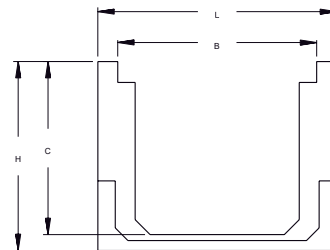
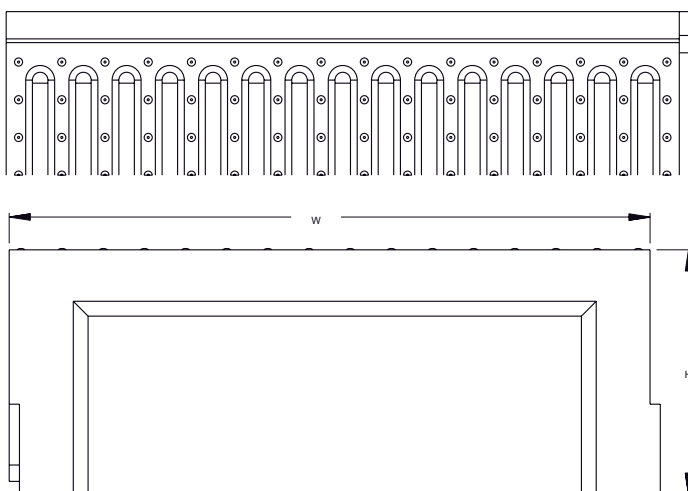

Code	W	L	H	C	B
	1000	230	75	60	200
2020.100K00.080.S	1000	230	95	80	200
	1000	230	115	100	200
2020.100K00.150.S	1000	230	165	150	200
	1000	230	215	200	200
2020.100K00.250.S	1000	230	265	250	200

## GRILL PATTERN OPTIONS



PLASTIC

- PP
- AISI 304
- AISI 430
- Galvanized
- Cast Iron



FISH

- AISI 304
- AISI 430
- Galvanized



SQUARE

- AISI 304
- AISI 430
- Galvanized



ROUND

- AISI 304
- AISI 430
- Galvanized



# GRID

# h10

## GRID 200 mm



Code	Length	Quality	Pattern	Price \$
2120.05021P304.2	200x500 mm	SS.304	SQUARE	27,78
2120.05021P304.3	200x500 mm	SS.304	LINE	27,78
2120.05021P304.4	200x500 mm	SS.304	STANDARD	26,67
2120.05021P304.5	200x500 mm	SS.304	ROUND	27,78
2120.05021P430.4	200x500 mm	Galvanized	STANDARD	10,57

канал / القناة

## GRID 200 mm



Code	Length	Quality	Pattern	Price \$
2120.05020D.000.4	200x500 mm	Cast Iron	STANDARD	36,00

канал / القناة

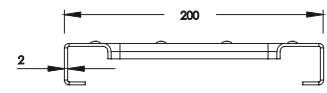
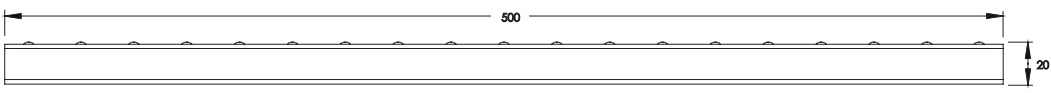
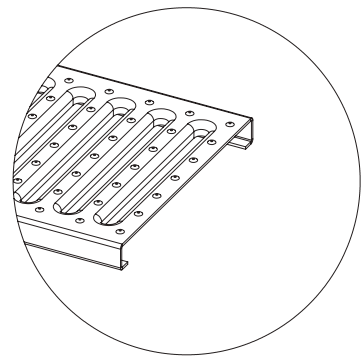
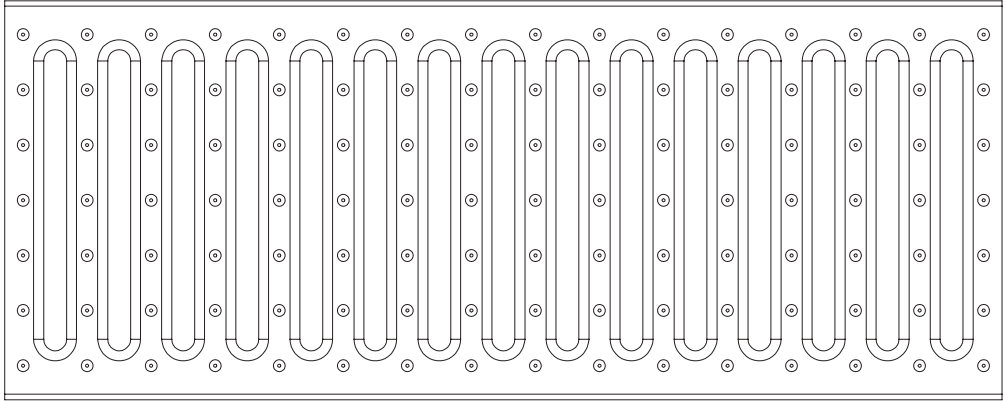

# DRAINAGE CHANNELS

h10



Polymer

## FRAMED POLYMER CHANNEL 300x1000 mm

Code	Length	Length		Price \$
2030.100K00.080.Ç	300x1000 mm	80 mm	-	61,78
2030.100K00.120.Ç	300x1000 mm	120 mm	-	69,27
2030.100K00.150.Ç	300x1000 mm	150 mm	-	79,57
2030.100K00.200.Ç	300x1000 mm	200 mm	-	91,73
2030.100K00.250.Ç	300x1000 mm	250 mm	-	112,33



Polymer

## CAP 300 mm

Code	Length	Length		Price \$
2030.000T00.080.S	300x80 mm	80 mm	-	7,50
2030.000T00.120.S	300x120 mm	120 mm	-	7,50
2030.000T00.150.S	300x150 mm	150 mm	-	7,50
2030.000T00.200.S	300x200 mm	200 mm	-	8,43
2030.000T00.250.S	300x250 mm	250 mm	-	8,43

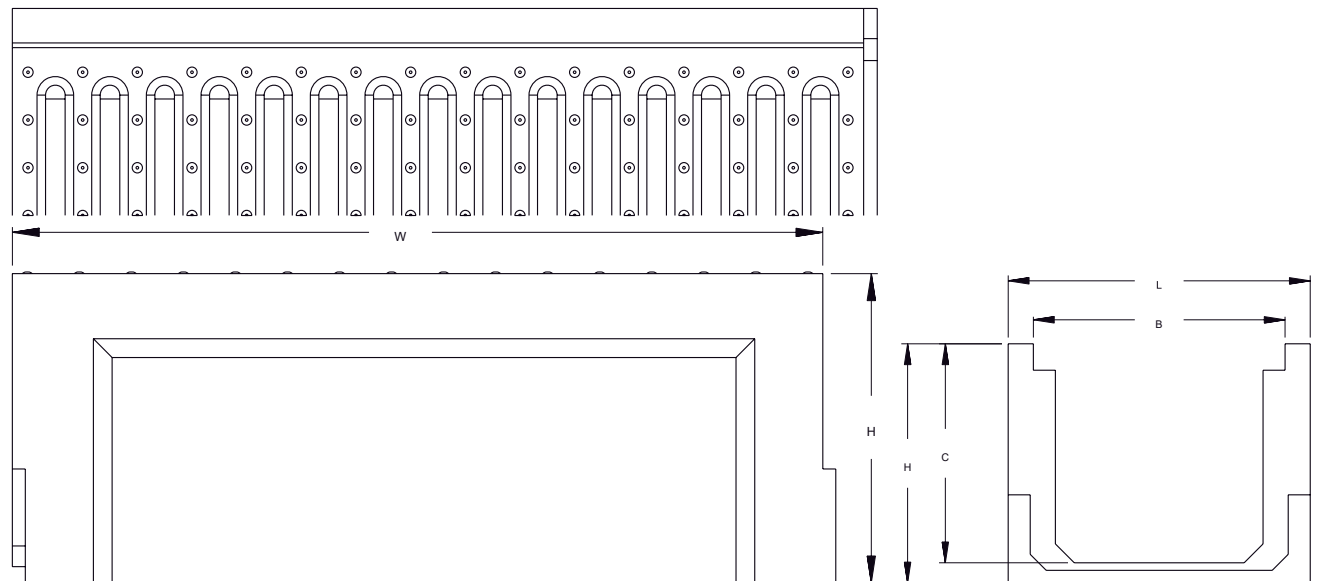
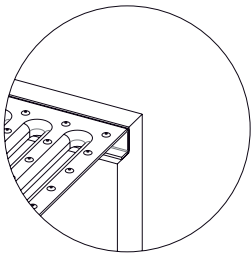

## GRILL PATTERN OPTIONS

Code	W	L	H	C	B
2020.100K00.100.S	1000	230	95	80	200
	1000	230	115	100	200
	1000	230	165	150	200
2020.100K00.200.S	1000	230	215	200	200
	1000	230	265	250	200



STANDARD

- AISI 304
- AISI 430
- Galvanized
- Cast Iron



SQUARE

- AISI 304
- AISI 430
- Galvanized



ROUND

- AISI 304
- AISI 430
- Galvanized

# GRID



## GRID 300 mm

Code	Length	Quality	Pattern	Price \$
2130.05021R304.4	300x500 mm	SS.304	SQUARE	60,57

канал / القناة



## GRID 300 mm

Code	Length	Quality	Pattern	Price \$
2130.05020D.000.4	300x500 mm	Cast Iron	STANDARD	56,17

канал / القناة

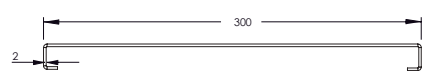
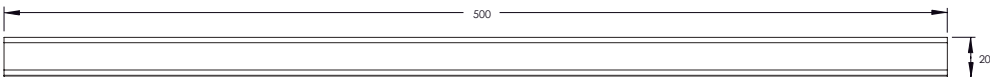
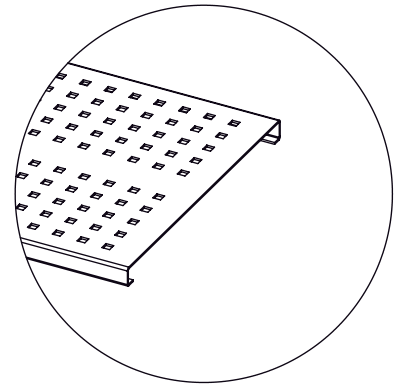
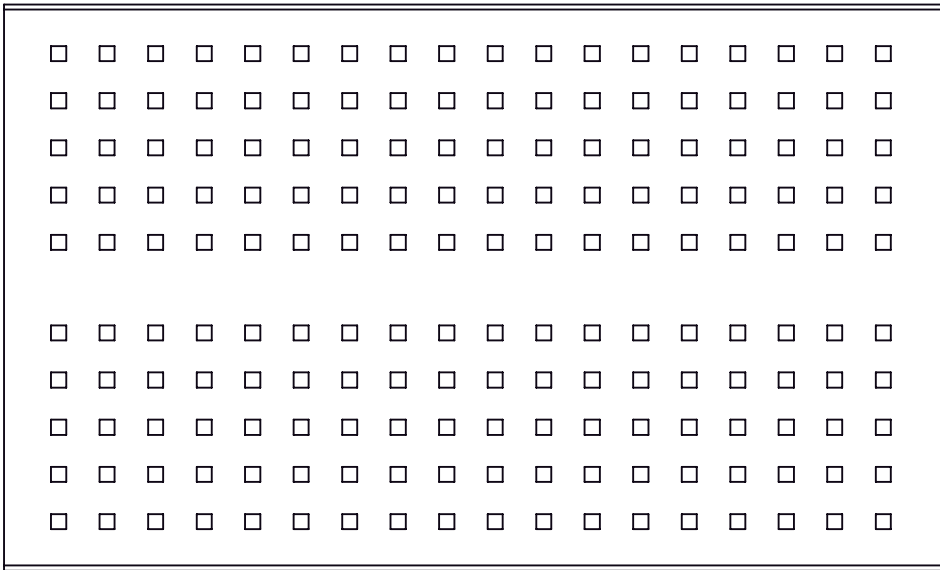

# CAR PARK DRAIN SIPHONS

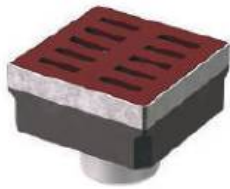

## A.Ç. 15x15

Code	Outlet	Length		Price \$
------	--------	--------	--	----------

2215.15A070.065.P	Ø 70	15x15 cm	-	51,48
-------------------	------	----------	---	-------

Polymer body / Iron grid / Odor blocking by water  
 полимер корпус / Чугунная сетка / Водный очиститель воздуха  
 هيكل من حديد الصلب الزهر / حابيس رائحة المياه



## A.Ç. 20x20

Code	Outlet	Length		Price \$
------	--------	--------	--	----------

2220.20A100.080.P	Ø 100	20x20 cm	-	65,53
-------------------	-------	----------	---	-------

Polymer body / Iron grid / Odor blocking by water  
 полимер корпус / Чугунная сетка / Водный очиститель воздуха  
 هيكل من حديد الصلب الزهر / حابيس رائحة المياه



## A.Ç. 30x30

Code	Outlet	Length		Price \$
------	--------	--------	--	----------

2220.30A100.070.P	Ø 100	20x20 cm	-	117,00
-------------------	-------	----------	---	--------

Polymer body / Iron grid / Odor blocking by water  
 полимер корпус / Чугунная сетка / Водный очиститель воздуха  
 هيكل من حديد الصلب الزهر / حابيس رائحة المياه

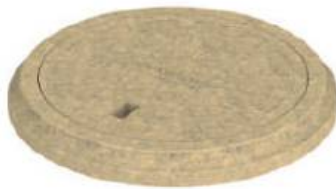

## ROUND MENHOL

Code	Length		Price \$
------	--------	--	----------

2375.075000.4.2	Ø 75	-	112,33
-----------------	------	---	--------

Polymer body / Полимерный корпус  
 هيكل بولييمر



## SQUARE MENHOL

Code	Length		Price \$
------	--------	--	----------

2350.050000.5.4	50x50 cm	-	182,53
2375.075000.5.2	75x75 cm	-	187,20

Polymer body / Полимерный корпус  
 هيكل بولييمر



## A.Ç. 200x500

Code	Outlet	Length		Price \$
------	--------	--------	--	----------

2230.50A070.100.P	Ø 100	200x500 cm	-	106,20
-------------------	-------	------------	---	--------

Polymer body / Iron grid / Odor blocking by water  
 полимер корпус / Чугунная сетка / Водный очиститель воздуха  
 هيكل من حديد الصلب الزهر / حابيس رائحة المياه



## A.Ç. 200x500

Code	Outlet	Length		Price \$
------	--------	--------	--	----------

2230.50A070.100.D	Ø 100	200x500 cm	-	98,65
-------------------	-------	------------	---	-------

Polymer body / Iron grid / Odor blocking by water  
 полимер корпус / Чугунная сетка / Водный очиститель воздуха  
 هيكل من حديد الصلب الزهر / حابيس رائحة المياه

# CAR PARK DRAIN SIPHONS

h10

DN 50 side and vertical outlet – compatible with PVC pipe connections, blocking odor by water (36mm). The flow rate is 32 liters/min.

Resistant against external chemical effects, operating temperature is between 30°C and +75°C. The grid is made of 304 grade stainless steel.

With its 304 grade stainless steel grid, it has a quality and stylish-looking. It can be easily applied at floor. With its odor blocking by water support, it prevents the bad smell coming from the installation. With its adjustable height legs, it can be adjusted depending on the screed concrete.

High resistance against the organic and inorganic chemicals, resistant against most acidic and salty aqueous oxidation.

Common use of bathroom shower, hospital and hotel shower areas, locker-room shower areas etc.

Grid patterns can be chosen in gold, bronze or other optional colors in accordance with your desire.

It is not recommended to use high-density cleaners for a long-time.

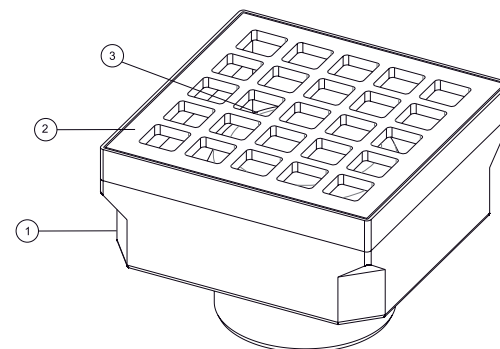

PART NO	PART DESCRIPTION	MATERIAL	PCS
	Polymer Body	Polymer	1
<b>2215.2</b>	Cast Iron	Cast Iron	1
	Odor blocking	Polymer	1

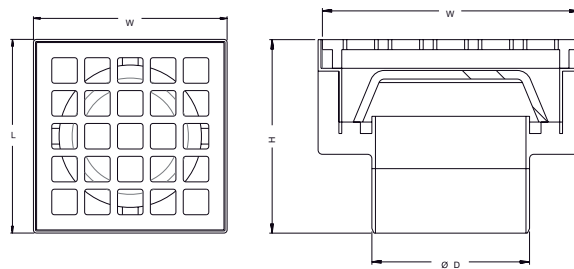

Code	W	L	H	Ø D
	144	144	115	74,5
<b>2220.20A100.080.P</b>	185	185	135	110
	304	304	139,5	100

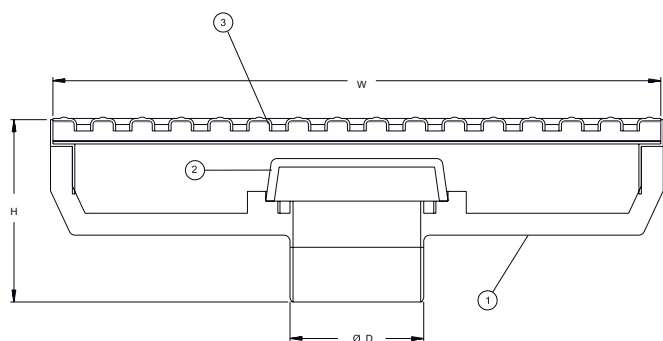

PART NO	PART DESCRIPTION	MATERIAL	PCS
	Polymer Body	Polymer	1
<b>2230.2</b>	Odor blocking	Polymer	1
	Metal Izgara	AISI 304 - Cast Iron	1

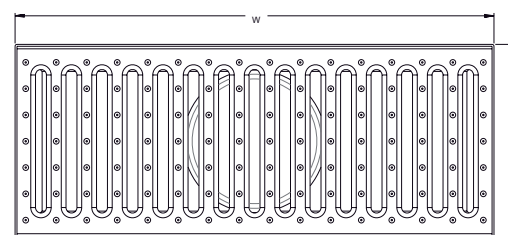

Code	W	L	H	Ø D
	504	204	150	110



# OUTDOOR DRAINS

# h10



## 20x20

Code	Outlet	Length		Price \$
------	--------	--------	--	----------

1101.2020Y0.070.0	Ø 70	20x20	30	4,07
-------------------	------	-------	----	------

Ø 70 side Outlet / Plastic body / Plastic grid / sludge chamber  
 Выход диаметром 70 / Пластиковый корпус / Пластиковая решетка  
 Камера грязевая

مصرف جانبي / هيكل بلاستيكي / خزان طين

1101.2020A0.070.0	Ø 70	20x20	30	3,87
-------------------	------	-------	----	------

Ø 70 bottom Outlet / Plastic body Plastic grid / sludge chamber  
 Нижний выход 100 / Пластиковый корпус / Пластиковая решетка  
 Камера грязевая

بمصرف سفلي / هيكل بلاستيكي / خزان طين

## 25x25

Code	Outlet	Length		Price \$
------	--------	--------	--	----------

1101.2525Y0.100.0	Ø 100	25x25	20	5,85
-------------------	-------	-------	----	------

Ø 100 side Outlet / Plastic body Plastic grid / sludge chamber  
 Выход диаметром 70 / Пластиковый корпус / Пластиковая решетка  
 Камера грязевая

مصرف جانبي / هيكل بلاستيكي / خزان طين

1101.2525A0.100.0	Ø 100	25x25	20	5,40
-------------------	-------	-------	----	------

Ø 100 bottom Outlet / Plastic body Plastic grid / sludge chamber  
 Нижний выход 100 / Пластиковый корпус / Пластиковая решетка  
 Камера грязевая

بمصرف سفلي / هيكل بلاستيكي / خزان طين

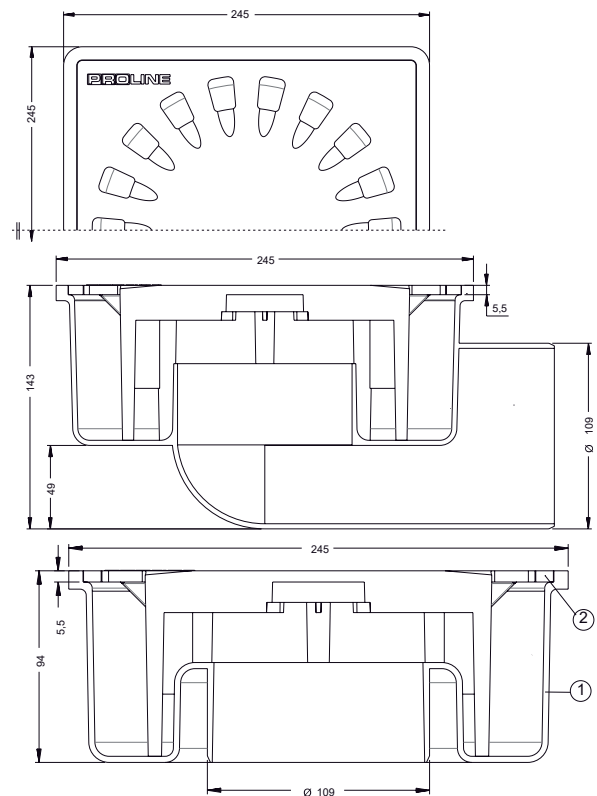
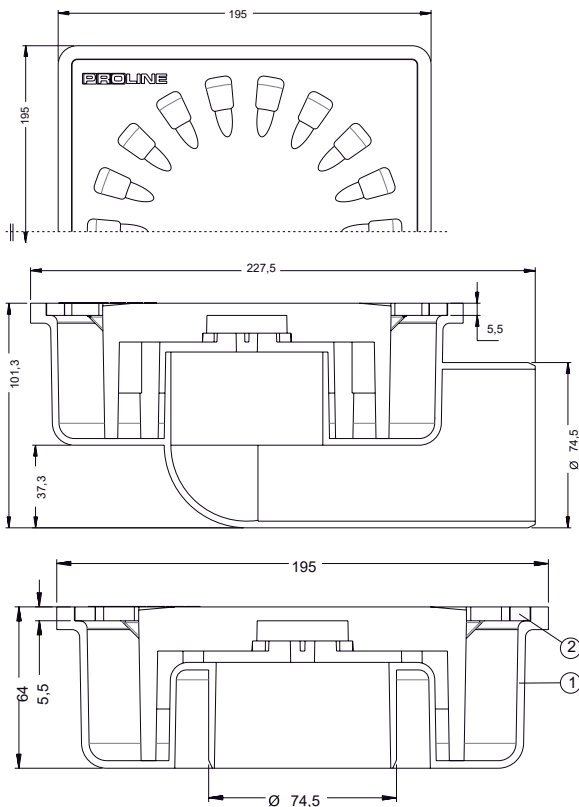

# WASTE WATER GROUP

# h10



## COVER SET

Code	Outlet	Length		Price \$
2601.222200.141.T	Set	22x22 cm	1	4,45
2601.333300.142.T	Set	33x33 cm	1	7,60
2601.393900.146.T	Set	39x39 cm	1	12,73
2601.434300.143.T	Set	43x43 cm	1	14,78
2601.454500.147.T	Set	45x45 cm	1	24,22
2601.525200.145.T	Set	52x52 cm	1	31,20
2601.585800.144.T	Set	58x58 cm	1	50,90

Plastic frame + cover / Рамка и крышка

غطاء بلاستيكي و شبكة



## PLASTIC MANHOLE SET

Code	Outlet	Length		Price \$
2602.202000.020.T	Set	20x20 cm	1	6,13
2602.303000.030.T	Set	30x30 cm	1	14,05
2602.353500.035.T	Set	35x35 cm	1	20,53
2602.404000.040.T	Set	40x40 cm	1	25,20
2602.505000.050.T	Set	50x50 cm	1	46,08
2602.555500.055.T	Set	55x55 cm	1	82,08

Plastic body + Cover / Комплект пластиковых люков

هيكل بلاستيكي و غطاء

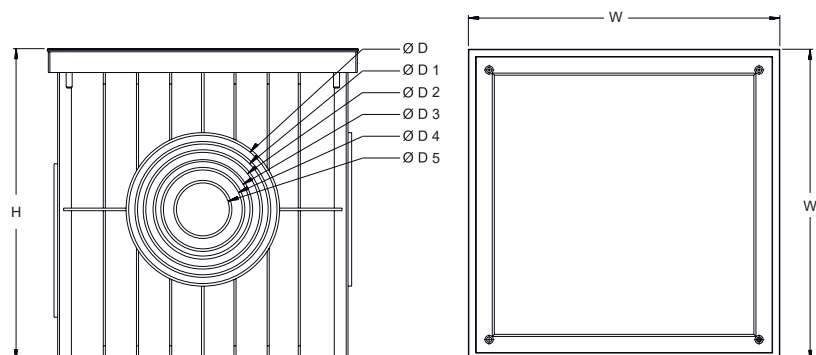

Code	W	L	H	Ø D	Ø D1	Ø D2	Ø D3	Ø D4	Ø D5
	200	19	200	-	-	110	91	76	51
2602.303000.030.T	300	23	300	143	126	101	92	76	51
	350	25	350	200	163	125	101	76	51
2602.404000.040.T	400	25	400	250	200	160	127	102	57
	500	29	460	320	250	200	160	125	101
2602.555500.055.T	550	37.5	520	-	-	320	250	200	161



## CHECKVALVES

Code	Outlet		Price \$
2766.00100.00.1	Ø 110	12	16,38
2766.00125.00.1	Ø 125	12	21,07
2766.00160.00.1	Ø 160	8	29,97
2766.00200.00.1	Ø 200	6	67,87

Stainless Clapper / Контрольный Клапан с замком

صمام / مقاوم للصدأ



# SIPHONS

# h10

## WC PAN CONNECTOR

Code	Outlet		Price \$
KD.1001.0110.B	Ø 110	24	4,68

ГИБКОЕ ПРОВОЛОЧНОЕ СОЕДИНЕНИЕ (ГОФРА)

## BASIN SIPHON

Code	Outlet	Length		Price \$
SS 304				
LS1001.0304.B	Ø 32	70 mm	100	2,60

## BASIN SIPHON

Code	Outlet	Length		Price \$
SS 430				
LS1001.0430.B	Ø 32	70 mm	100	2,53





## SHELVING UNIT

Полочка / رف

Code	Quantity	Price \$
AK.01.3901.P	12	25,45



## SOAP HOLDER

Мыльница  
علبة صابون

Code	Quantity	Price \$
AK.01.3903.P	27	18,73



## TOOTH BRUSH HOLDER

Держатель для зубных щеток  
علبة فراشي أسنان

Code	Quantity	Price \$
AK.01.3904.P	10	18,73



## TOWEL RING

Круглый полотенцедержатель  
علاقة مناشف دائري

Code	Quantity	Price \$
AK.01.3917.P	15	19,38



## LONG TOWEL HOLDER

длинный полотенцедержатель /  
علاقة مناشف طويلة

Code	Quantity	Price \$
AK.06.3914.P	15	26,72



## BATHROBE HANGER

Вешалка для банных халатов с двумя крючками  
علاقة بورتوز

Code	Quantity	Price \$
AK.08.3927.P	90	12,47



## PAPER DISPENSERS

Открытый держатель для бумаги  
موزعات ورق مرحاض

Code	Quantity	Price \$
AK.04.3907.P	36	17,22



## COVERED PAPER DISPENSERS

Держатель для бумаги с крышкой  
موزعات ورق بأغطية

Code	Quantity	Price \$
AK.05.3908.P	27	24,13



## SHELVING UNIT

Полочка / رف

Code



Price \$

AK.11.3901.G

12

50,12



## TOOTH BRUSH HOLDER

Держатель для зубных щеток  
علبة فراشي أسنان

Code



Price \$

AK.13.3904.G

10

37,45



## LONG TOWEL HOLDER

длинный полотенцедержатель /  
علاقة مناشف طويلة

Code



Price \$

AK.16.3914.G

15

53,43



## PAPER DISPENSERS

Открытый держатель для бумаги  
موزعات ورقى مرحاض

Code



Price \$

AK.14.3907.G

36

34,42



## SOAP HOLDER

Мыльница  
علبة صابون

Code



Price \$

AK.12.3903.G

27

37,45



## TOWEL RING

Круглый полотенцедержатель  
علاقة مناشف دائري

Code



Price \$

AK.17.3917.G

15

38,75



## BATHROBE HANGER

Вешалка для банных халатов с двумя крючками  
علاقة بورتуз

Code



Price \$

AK.18.3927.G

90

24,92



## COVERED PAPER DISPENSERS

Держатель для бумаги с крышкой  
موزعات ورقى بأغطية

Code



Price \$

AK.15.3908.G

27

48,25

# JUPITER SERIES

h10



## SHELVING UNIT

Полочка / رف

Code



Price \$

AK.20.3401.P

9

22,90



## TOOTH BRUSH HOLDER

Держатель для зубных щеток  
علبة فراشي أسنان

Code



Price \$

AK.22.3404.P

25

15,85



## LONG TOWEL HOLDER

длинный полотенцедержатель /  
علاقة مناشف طويلة

Code



Price \$

AK.26.3414.P

15

18,65



## PAPER DISPENSERS

Открытый держатель для бумаги  
موزعات ورق مرحاض

Code



Price \$

AK.23.3407.P

36

10,60



## BATHROBE HANGER

ВЕШАЛКА ДЛЯ БАННЫХ ХАЛАТОВ С ДВУМЯ КРЮЧКАМИ  
علاقة بورنوز

Code



Price \$

AK.28.3426.P

135

7,78



## SOAP HOLDER

Мыльница  
علبة صابون

Code



Price \$

AK.21.3403.P

30

15,85



## TOWEL RING

Круглый полотенцедержатель  
علاقة مناشف دائري

Code



Price \$

AK.27.3417.P

16

14,77



## BATHROBE HANGER

ВЕШАЛКА ДЛЯ БАННЫХ ХАЛАТОВ С ДВУМЯ КРЮЧКАМИ  
علاقة بورنوز

Code



Price \$

AK.29.3427.P

50

15,05



## COVERED PAPER DISPENSERS

Держатель для бумаги с крышкой  
موزعات ورق باغطية

Code



Price \$

AK.24.3408.P

23

14,48



## COVERED PAPER TOWEL

ДЕРЖАТЕЛЬ ДЛЯ БУМАЖНЫХ ПОЛОТЕНЕЦ С КРЫШКОЙ  
علاقة مناشف يغطاء

Code



Price \$

AK.25.3413.P

15

15,70

# JUPITER GOLD SERIES

h10



## SHELVING UNIT

Полочка / رف

Code



Price \$

AK.31.3401.G

9

45,80



## TOOTH BRUSH HOLDER

Держатель для зубных щеток  
علبة فراشي أسنان

Code



Price \$

AK.33.3404.G

25

31,68



## LONG TOWEL HOLDER

длинный полотенцедержатель /  
علاقة مناشف طويلة

Code



Price \$

AK.37.3414.G

15

37,30



## PAPER DISPENSERS

Открытый держатель для бумаги  
موزعات ورق مرحاض

Code



Price \$

AK.34.3407.G

36

21,18



## BATHROBE HANGER

Вешалка для банных халатов с двумя крючками  
علاقة بورتوز

Code



Price \$

AK.39.3426.G

135

15,57



## SOAP HOLDER

Мыльница  
علبة صابون

Code



Price \$

AK.32.3403.G

30

31,68



## TOWEL RING

Круглый полотенцедержатель  
علاقة مناشف دائري

Code



Price \$

AK.38.3417.G

16

29,53



## BATHROBE HANGER

Вешалка для банных халатов с двумя крючками  
علاقة بورتوز

Code



Price \$

AK.40.3427.G

50

30,10



## COVERED PAPER DISPENSERS

Держатель для бумаги с крышкой  
موزعات ورق بأغطية

Code



Price \$

AK.35.3408.G

23

28,95



## COVERED PAPER TOWEL

Держатель для бумажных полотенец с крышкой  
علاقة مناشف بغطاء

Code



Price \$

AK.36.3413.G

15

31,40

# MARS SERIES

h10



## SHELVING UNIT

Полочка /  
رف

Code



Price \$

AK.61.3501.P

12

5,55



## TOOTH BRUSH HOLDER

Держатель для зубных щеток  
علبة فرشاة أسنان

Code



Price \$

AK.62.3504.P

20

3,18



## LONG TOWEL HOLDER

длинный полотенцедержатель /  
علاقة مناشف طويلة

Code



Price \$

AK.65.3514.P

15

5,27



## PAPER DISPENSERS

Открытый держатель для бумаги  
موزعات ورق مرحاض

Code



Price \$

AK.67.3507.P

20

3,10



## SOAP HOLDER

Мыльница  
علبة صابون

Code



Price \$

AK.63.3503.P

16

3,18



## TOWEL RING

Круглый полотенцедержатель  
علاقة مناشف دائري

Code



Price \$

AK.64.3517.P

15

3,97



## BATHROBE HANGER

ВЕШАЛКА ДЛЯ БАННЫХ ХАЛАТОВ С ДВУМЯ КРЮЧКАМИ  
علاقة بورتونز

Code



Price \$

AK.66.3527.P

50

2,97



## COVERED PAPER DISPENSERS

Держатель для бумаги с крышкой  
موزعات ورق باغطية

Code



Price \$

AK.68.3508.P

20

3,82

- Chrome plated
- Aluminum Body

- SS 430 Quality STAINLESS Badge and cover
- Iron bar
- Blister Packaging



**NEW!**



## SHELVING UNIT

Полочка / رف

Code



Price \$

AK.74.3801.P

5

26,07



## TOOTH BRUSH HOLDER

Держатель для зубных щеток  
علبة فرشاة أسنان

Code



Price \$

AK.76.3804.P

14

18,43



## LONG TOWEL HOLDER

длинный полотенцедержатель /  
علاقة مناشف طويلة

Code



Price \$

AK.80.3814.P

10

27,80



## PAPER DISPENSERS

Открытый держатель для бумаги  
موزعات ورق مرحاض

Code



Price \$

AK.77.3807.P

24

14,10



## SOAP HOLDER

Мыльница  
علبة صابون

Code



Price \$

AK.75.3803.P

16

18,43



## TOWEL RING

Круглый полотенцедержатель  
علاقة مناشف دائري

Code



Price \$

AK.79.3817.P

8

21,47



## BATHROBE HANGER

ВЕШАЛКА ДЛЯ БАННЫХ ХАЛАТОВ С ДВУМЯ КРЮЧКАМИ  
علاقة بورتونز

Code



Price \$

AK.81.3827.P

50

13,90



## COVERED PAPER DISPENSERS

Держатель для бумаги с крышкой  
موزعات ورق بأغطية

Code



Price \$

AK.78.3808.P

8

18,43

- Chrome plated
- Brass Body

- SS 304 Quality STAINLESS cover, Badge and stick
- Box packaging

# NEPTUN SERIES

h10



**NEW!**

## SHELVING UNIT

Полочка / رف

Code



Price \$

AK.88.3301.P

5

27,43



## TOOTH BRUSH HOLDER

Держатель для зубных щеток

علبة فراشي أسنان

Code



Price \$

AK.90.3304.P

14

16,85



## LONG TOWEL HOLDER

длинный полотенцедержатель /

علاقة مناشف طويلة

Code



Price \$

AK.93.3314.P

10

32,92



## PAPER DISPENSERS

Открытый держатель для бумаги

موزعات ورق مرحاض

Code



Price \$

AK.91.3307.P

16

20,17



## SOAP HOLDER

Мыльница  
علبة صابون

Code



Price \$

AK.89.3303.P

16

16,85



## TOWEL RING

Круглый полотенцедержатель

علاقة مناشف دائري

Code



Price \$

AK.92.3317.P

8

23,27



## BATHROBE HANGER

ВЕШАЛКА ДЛЯ БАННЫХ ХАЛАТОВ С ДВУМЯ КРЮЧКАМИ

علاقة بورتوز

Code



Price \$

AK.94.3327.P

50

14,94



## BATHROBE HANGER

ВЕШАЛКА ДЛЯ БАННЫХ ХАЛАТОВ С ДВУМЯ КРЮЧКАМИ

علاقة بورتوز

Code



Price \$

AK.96.3326.P

50

13,62

- Chrome plated
- Brass Body

- SS 304 Quality STAINLESS cover, Badge and stick
- Box packaging

# NEPTUN GOLD SERIES

h10



## SHELVING UNIT

Полочка /  
رف

Code



Price \$

AK100.3301.G

5

37,52



## TOOTH BRUSH HOLDER

Держатель для зубных щеток  
علبة فراشي أسنان

Code



Price \$

AK102.3304.G

14

21,90



## LONG TOWEL HOLDER

длинный полотенцедержатель /  
علاقة مناشف طويلة

Code



Price \$

AK105.3314.G

10

43,00



## PAPER DISPENSERS

Открытый держатель для бумаги  
موزعات ورق مرحاض

Code



Price \$

AK103.3307.G

16

25,20



## SOAP HOLDER

Мыльница  
علبة صابون

Code



Price \$

AK101.3303.G

16

21,90



## TOWEL RING

Круглый полотенцедержатель  
علاقة مناشف دائري

Code



Price \$

AK104.3317.G

8

28,30



## BATHROBE HANGER

ВЕШАЛКА ДЛЯ БАННЫХ ХАЛАТОВ С ДВУМЯ КРЮЧКАМИ  
علاقة بورتوز

Code



Price \$

AK106.3327.G

50

19,95



## BATHROBE HANGER

ВЕШАЛКА ДЛЯ БАННЫХ ХАЛАТОВ С ДВУМЯ КРЮЧКАМИ  
علاقة بورتوز

Code



Price \$

AK108.3326.G

50

18,65

- Chrome plated
- Brass Body

- SS 304 Quality STAINLESS cover, Badge and stick
- Box packaging

# NEPTUN BLACK SERIES

h10



## SHELVING UNIT

Полочка /  
رف

Code



Price \$

AK.II2.3301.B

5

54,87



## TOOTH BRUSH HOLDER

Держатель для зубных щеток /  
علبة فرشاة أسنان

Code



Price \$

AK.II4.3304.B

14

33,70



## LONG TOWEL HOLDER

длинный полотенцедержатель /  
علاقة مناشف طويلة

Code



Price \$

AK.II7.3314.B

10

65,82



## PAPER DISPENSERS

Открытый держатель для бумаги /  
موزعات ورق مرحاض

Code



Price \$

AK.II5.3307.P

16

40,33



## SOAP HOLDER

Мыльница  
علبة صابون

Code



Price \$

AK.II3.3303.B

16

33,70



## TOWEL RING

Круглый полотенцедержатель /  
علاقة مناشف دائري

Code



Price \$

AK.II6.3317.B

8

46,52



## BATHROBE HANGER

ВЕШАЛКА ДЛЯ БАННЫХ ХАЛАТОВ С ДВУМЯ КРЮЧКАМИ /  
علاقة بورتوز

Code



Price \$

AK.II8.3327.B

50

29,82



## BATHROBE HANGER

ВЕШАЛКА ДЛЯ БАННЫХ ХАЛАТОВ С ДВУМЯ КРЮЧКАМИ /  
علاقة بورتوز

Code



Price \$

AK.I20.3326.B

50

33,27

- Black color
- Brass Body

- SS 304 Quality STAINLESS cover, Badge and stick
- Box packaging

# VESTA SERIES



## SHELVING UNIT

Полочка / رف

Code



Price \$

AK137.3101.P

5

27,43



## TOOTH BRUSH HOLDER

Держатель для зубных щеток

علبة فراشي أسنان

Code



Price \$

AK138.3104.P

14

16,85



## LONG TOWEL HOLDER

длинный полотенцедержатель /

علاقة مناشف طويلة

Code



Price \$

AK140.3114.P

10

32,92



## PAPER DISPENSERS

Открытый держатель для бумаги

موزعات ورق مرحاض

Code



Price \$

AK142.3107.P

16

25,00



## SOAP HOLDER

Мыльница

علبة صابون

Code



Price \$

AK139.3103.P

16

16,85



## TOWEL RING

Круглый полотенцедержатель

علاقة مناشف دائري

Code



Price \$

AK144.3117.P

8

23,27



## BATHROBE HANGER

ВЕШАЛКА ДЛЯ БАННЫХ ХАЛАТОВ С ДВУМЯ КРЮЧКАМИ

علاقة بورتوز

Code



Price \$

AK141.3127.P

50

14,92



## COVERED PAPER DISPENSERS

Держатель для бумаги с крышкой

موزعات ورق باغظية

Code



Price \$

AK143.3108.P

16

139,80

- Chrome plated
- Brass Body

**h10**

- SS 304 Quality STAINLESS cover, Badge and stick
- Box packaging

# BETA SERIES

h10



## SHELVING UNIT

Полочка /  
رف

Code		Price \$
AK.31.3601.P	16	12,47



## SOAP HOLDER

Мыльница  
علبة صابون

Code		Price \$
AK.32.3603.P	25	8,28



## TOOTH BRUSH HOLDER

Держатель для зубных щеток  
علبة فراشي أسنان

Code		Price \$
AK.33.3604.P	25	8,28



## TOWEL RING

Круглый полотенцедержатель  
علقة مناشف دائري

Code		Price \$
AK.42.3617.P	20	9,08



## LONG TOWEL HOLDER

длинный полотенцедержатель /  
علقة مناشف طويلة

Code	Uzunluk		Price \$
AK.40.3614.P	40 cm	25	13,47
AK.41.3615.P	50 cm	25	15,48



## DOUBLE TOWEL HOLDER

двойной держатель для полотенец  
علقة مناشف مزدوجة

Code		Price \$
AK.43.3618.P	15	24,48



## PAPER DISPENSERS

Открытый держатель для бумаги  
موزعات ورق مرحاض

Code		Price \$
AK.34.3607.P	40	7,78



## COVERED PAPER DISPENSERS

Держатель для бумаги с крышкой  
موزعات ورق باغظية

Code		Price \$
AK.35.3608.P	30	10,08

- Chrome plated
- Brass Body

- SS 304 Quality STAINLESS cover, Badge and stick
- Blister packaging

# BETA SERIES

h10



## PAPER TOWEL

ДЕРЖАТЕЛЬ БУМАЖНЫХ ПОЛОТЕНЕЦ

علاقة مناشف

Code



Price \$

AK.38.3612.P

25

10,08



## COVERED PAPER TOWEL

ДЕРЖАТЕЛЬ ДЛЯ БУМАЖНЫХ ПОЛОТЕНЕЦ С КРЫШКОЙ

علاقة مناشف بغطاء

Code



Price \$

AK.39.3613.P

15

12,40



## SPARE ROLL HOLDER

ДЕРЖАТЕЛЬ ДЛЯ БУМАГИ ДОПОЛНИТЕЛЬНЫЙ

علاقة إضافية

Code



Price \$

AK.46.3641.P

10

12,40



## TOILET PAPER HOLDER WITH SPARE HOLDER

ДЕРЖАТЕЛЬ ДЛЯ БУМАГИ С ДОПОЛНИТЕЛЬНОЙ ШТАНГОЙ

موزعة اوراق بطلاقة

Code



Price \$

AK.37.3610.P

10

17,22



## OVAL SOAP HOLDER

ОВАЛЬНАЯ МЫЛЬНИЦА РЕШЕТКА

حامل صابون سلكي

Code



Price \$

AK.36.3609.P

20

16,85



## BATHROBE HANGER

ВЕШАЛКА ДЛЯ БАННЫХ ХАЛАТОВ С ДВУМЯ КРЮЧКАМИ

علاقة بورتوز

Code



Price \$

AK.44.3621.P

75

7,07



## QUADRUPLE HANGERS

НАБОР ВЕШАЛОК С ЧЕТЫРЬМЯ КРЮЧКАМИ

مجموعة علاقة رباعية

Code



Price \$

AK.45.3629.P

10

19,60

# VENUS SERIES

h10



## SHELVING UNIT

Полочка  
رف

Code



Price \$

AK.48.3701.P

16

9,52



## BATHROBE HANGER

ВЕШАЛКА ДЛЯ БАННЫХ ХАЛАТОВ С ДВУМЯ КРЮЧКАМИ  
علاقة بورتوز

Code



Price \$

AK.56.3727.P

75

4,55



## LONG TOWEL HOLDER

длинный полотенцедержатель  
علاقة مناشف طويلة

Code



Price \$

AK.54.3714.P

25

10,25



## PAPER DISPENSERS

Открытый держатель для бумаги  
موزعات ورق مرحاض

Code



Price \$

AK.51.3707.P

40

4,90



## PAPER DISPENSERS

ДЕРЖАТЕЛЬ БУМАЖНЫХ ПОЛОТЕНЕЦ  
علاقة مناشف

Code



Price \$

AK.53.3712.P

15

6,35



## SOAP HOLDER

Мыльница  
علبة صابون

Code



Price \$

AK.49.3703.P

25

7,72



## TOOTH BRUSH HOLDER

Держатель для зубных щеток  
علبة فراشي أسنان

Code



Price \$

AK.50.3704.P

25

7,72



## TOWEL RING

Круглый полотенцедержатель  
علاقة مناشف دائري

Code



Price \$

AK.55.3717.P

20

7,63



## COVERED PAPER DISPENSERS

ДЕРЖАТЕЛЬ ДЛЯ БУМАГИ С КРЫШКОЙ  
موزعات ورق بأغطية

Code



Price \$

AK.52.3708.P

30

6,20



# MIRRORS



## OVAL MIRROR

ОВАЛЬНОЕ ЗЕРКАЛО  
مرآة بيضاوية

Code	Length		Price \$
AK.94.4002.A	55x75 cm	5	25,20



## LAVI MIRROR

АРЧНОЕ ЗЕРКАЛО  
LAVI مرآة

Code	Length		Price \$
AK.90.4202.A	40x50 cm	5	15,85



## MAKE UP MIRROR

ЗЕРКАЛО ДЛЯ МАКИЯЖА  
مرآة مكياج

Code		Price \$
AK.96.3001.A	20	63,37

h10



## RECTANGULAR MIRROR

ПРЯМОУГОЛЬНОЕ ЗЕРКАЛО  
مرآة مستطيلة

Code	Length		Price \$
AK.95.4102.A	55x75 cm	5	25,20



## MIRA MIRROR

ЗЕРКАЛО МИРА  
MIRA مرآة

Code	Length		Price \$
AK.91.4301.A	40x50 cm	5	15,13
AK.92.4302.A	40x60 cm	5	17,28
AK.93.4303.A	50x70 cm	5	21,60



## MAKE UP MIRROR WITH LED

ЗЕРКАЛО ДЛЯ МАКИЯЖА  
مرآة مكياج مع الصمام

Code		Price \$
AK.97.3002.A	20	106,93

# ACCESSORIES SERIES

h10



- \* Mira Mirror 40X50 cm
- \* Shelving Unit
- \* Towel Ring
- \* Toilet Paper Holder
- \* Tooth Brush Holder
- \* Soap Holder

## VENUS MIRROR SET 5+1

НАБОР ЗЕРКАЛ ВЕНУС 5+1

Code

Length



Price \$

AK220.3700.P

40x50 cm

6

32,40





## SINGLE CORNER SPONGE HOLDER

УГЛОВАЯ КОРЗИНКА-РЕШЕТКА ОДНА  
حمالة اسفنجة زاوية مفردة

Code	Length		Price \$
AK.60.6015.K	15x15 cm	1	14,77
AK.61.6018.K	18x18 cm	1	15,92



## DOUBLE CORNER SPONGE

УГЛОВАЯ КОРЗИНКА-РЕШЕТКА ДВОЙНАЯ  
حمالة اسفنجة زاوية ثنائية

Code	Length		Price \$
AK.67.6115.K	15x15 cm	10	31,83
AK.61.6118.K	18x18 cm	10	34,20



## TRIPLE CORNER SPONGE HOLDER

УГЛОВАЯ КОРЗИНКА-РЕШЕТКА ТРОЙНАЯ  
حمالة اسفنجة زاوية ثلاثية

Code	Length		Price \$
AK.72.6215.K	15x15 cm	10	48,60
AK.73.6218.K	18x18 cm	10	52,13



## SINGLE OVAL SPONGE HOLDER

ОВАЛЬНАЯ КОРЗИНКА-РЕШЕТКА ОДНА  
حمالة اسفنجة بيضاوية مفردة

Code	Length		Price \$
AK.62.6519.K	19x19 cm	1	17,58



## DOUBLE OVAL SPONGE

ОВАЛЬНАЯ КОРЗИНКА-РЕШЕТКА ДВОЙНАЯ  
حمالة اسفنجة بيضاوية ثنائية

Code	Length		Price \$
AK.69.6619.K	19x19 cm	10	38,88



## TRIPLE OVAL SPONGE HOLDER

ОВАЛЬНАЯ КОРЗИНКА-РЕШЕТКА ТРОЙНАЯ  
حمالة اسفنجة بيضاوية ثلاثية

Code	Length		Price \$
AK.254.6719.K	19x19 cm	10	59,33

# SOAP HOLDER



## SQUARE SOAP HOLDER

КВАДРАТНАЯ МЫЛЬНИЦА

Code	Length		Price \$
AK.75.7501.K	12x9 cm	25	13,62



## TYPE A HOOK SET

НАБОР КРЮЧКОВ ТИПА А

مجموعة علاقة نوع A

Code	Length		Price \$
AK.280.8002.A	2'li Set Askılık	50	7,13
AK.281.8003.A	3'lü Set Askılık	50	9,65
AK.281.8004.A	4'lü Set Askılık	40	12,53
AK.282.8005.A	5'li Set Askılık	50	15,20



## TYPE B HOOK SET

НАБОР КРЮЧКОВ ТИПА Б

مجموعة علاقة نوع B

Code	Length		Price \$
AK.285.8002.B	2'li Set Askılık	50	6,85
AK.286.8003.B	3'lü Set Askılık	50	9,15
AK.286.8004.B	4'lü Set Askılık	40	11,88
AK.287.8005.B	5'li Set Askılık	50	14,55





## SHELF TOWEL

ПОЛОЧКА ДЛЯ ПОЛОТЕНЕЦ  
رف مناشف

Code	Diameter	Length	Quality		Price \$
4949.305IS.304.00	Ø 19	50x29x12,5 cm	S.S. 304	12	26,28



## SHELF TOWEL

ПОЛОЧКА ДЛЯ ПОЛОТЕНЕЦ  
رف مناشف

Code	Diameter	Length	Quality		Price \$
4949.3162S.304.00	Ø 19	50x20x13 cm	S.S. 304	20	21,98



## SUPPORTED ANGLED TOWEL HOLDER

ПОЛОЧКА ДЛЯ ПОЛОТЕНЕЦ НА КРОНШТЕЙНЕ  
رف مناشف زاوية مدعوم

Code	Diameter	Length	Quality		Price \$
4950.5019S.304.00	Ø 19	50x29x18,5 cm	S.S. 304	12	23,37



## SUPPORT TOWEL HOLDER

ПОЛОЧКА ДЛЯ ПОЛОТЕНЕЦ НА КРОНШТЕЙНЕ  
رف مناشف مدعوم

Code	Diameter	Length	Quality		Price \$
4950.3162S.304.00	Ø 19	50x29x12 cm	S.S. 304	12	23,37

# SOAP HOLDER



Bright

## TOOTH BRUSH HOLDER

ДЕРЖАТЕЛЬ ДЛЯ ЗУБНЫХ ЩЕТОК

علبة فرشاشي أسنان

Code	Length	Quality		Price \$
4711.22.711.0	Ø 7x11 cm	S.S. 304	20	5,57



## COUNTERTOP / SUSPENSION

НАБАЛДАШНИКИ / ПОДВЕСНЫЕ

موزع الصابون

Code	Length	Quality		Price \$
4711.17.718.0	Ø 7x17 cm	S.S. 304	20	9,47
4711.16.717.0	Askil Ø 7x17 cm	S.S. 304	20	12,32



## LIQUID SOAP BUILT-IN DISPENSER

Code	Diameter	Length	Quality		Price \$
4716.0921S.304.00	Ø 9	21 cm	S.S. 304	20	12,82

# h10



Wall Mounting

Plastic Pump

Mat

Bright

## FOAM DISPENSER

ПЕНА

رغوة

Code	Capacity	Length	Quality		Price \$
4711.09.100.M	1000 ml	22x7x13 cm	S.S. 304	20	20,77
4711.09.100.P	1000 ml	22x7x13 cm	S.S. 304	20	20,77



## SPHERE COUNTERTOP

СФЕРИЧЕСКИЕ НАБАЛДАШНИКИ ДЛЯ НАБОРОВ ДОЗАТОРОВ

موزع الصابون

Code	Length	Quality		Price \$
4711.19.916.0	Ø 9x15 cm	S.S. 304	20	10,03



## FOAM BUILT-IN DISPENSER

ДОЗАТОРЫ

منمچ

Code	Diameter	Length	Quality		Price \$
4716.0921S.304.01	Ø 9	21 cm	S.S. 304	20	35,84

# LIQUID SOAP DISPENSERS



Wall Mounting

Plastic Pump

Bright

## LIQUID SOAP DISPENSER

ЖИДКОЕ МЫЛО ДИСПЕНСЕР  
موزع الصابون

Code	Capacity	Length	Quality		Price \$
4711.02.050.P	500 ml	15x6x10 cm	S.S. 304	20	17,00
4711.06.100.P	1000 ml	22x6x13 cm	S.S. 304	20	17,55



Wall Mounting

Plastic Pump

## LIQUID SOAP DISPENSER

ЖИДКОЕ МЫЛО ДИСПЕНСЕР  
موزع الصابون

Code	Capacity	Length	Quality		Price \$
4711.01.050.M	500 ml	15x6x10 cm	S.S. 304	20	13,97
4711.05.100.M	1000 ml	22x6x13 cm	S.S. 304	20	16,93



Wall Mounting

Brass Pump

Bright

## LIQUID SOAP DISPENSER

ЖИДКОЕ МЫЛО ДИСПЕНСЕР  
موزع الصابون

Code	Capacity	Length	Quality		Price \$
4711.04.050.P	500 ml	15x6x10 cm	S.S. 304	20	17,00
4711.08.100.P	1000 ml	22x6x13 cm	S.S. 304	20	19,97



Wall Mounting

Brass Pump

Mat

## LIQUID SOAP DISPENSER

ЖИДКОЕ МЫЛО ДИСПЕНСЕР  
موزع الصابون

Code	Capacity	Length	Quality		Price \$
4711.03.050.M	500 ml	15x6x10 cm	S.S. 304	20	16,57
4711.07.100.M	1000 ml	22x6x13 cm	S.S. 304	20	19,97

# PAPER DISPENSERS

h10



Code	Size	Quality	Price \$
------	------	---------	----------

## OVAL S.S. 430

4546.2610S.430.00	100x26x12 cm	SS. 430	1 65,57
-------------------	--------------	---------	---------

## OVAL S.S. 304

4546.2610S.304.00	100x26x12 cm	SS. 304	1 96,67
-------------------	--------------	---------	---------

## OVAL 400 PAPER DISPENSER WITH DUST BINS

**БУМАГОДЕРЖАТЕЛЬ С МУСОРНЫМ КОНТЕЙНЕРОМ 400 ПРЯМОЙ**  
 علية ورق مرحاض عدد ٤٠٠ بيضاوية مع سطل قمامة

## FLAT S.S. 430

4549.2610S.430.00	100x26x12 cm	SS. 430	1 65,57
-------------------	--------------	---------	---------

## FLAT S.S. 304

4549.2610S.304.00	100x26x12 cm	SS. 304	1 96,67
-------------------	--------------	---------	---------

## FLAT 400 PAPER DISPENSER WITH DUST BINS

**БУМАГОДЕРЖАТЕЛЬ С МУСОРНЫМ КОНТЕЙНЕРОМ 400 ПРЯМОЙ**  
 علية ورق مرحاض عدد ٤٠٠ بيضاوية مع سطل قمامة

## SURFACE MOUNTED PAPER DISPENSER

Code	Size	Quality	Price \$
------	------	---------	----------

## SINGLE S.S. 430

4941.1616S.430.00	16x16 cm	SS. 430	5 19,80
-------------------	----------	---------	---------

## SINGLE S.S. 304

4941.1616S.304.00	16x16 cm	SS. 304	5 24,48
-------------------	----------	---------	---------

**БУМАГОДЕРЖАТЕЛЬ НАРУЖНОГО КРЕПЛЕНИЯ**  
 موزع ورق مرحاض فوق الجص مفرد

## DOUBLE S.S. 430

4942.3216S.430.00	32x16 cm	SS. 430	5 38,17
-------------------	----------	---------	---------

## DOUBLE S.S. 304

4942.3216S.304.00	32x16 cm	SS. 304	5 47,53
-------------------	----------	---------	---------

**ДВОЙНОЙ БУМАГОДЕРЖАТЕЛЬ НАРУЖНОГО КРЕПЛЕНИЯ**  
 موزع ورق مرحاض فوق الجص مزدوج

## BUILT-IN PAPER DISPENSER

Code	Size	Quality	Price \$
------	------	---------	----------

## SINGLE S.S. 430

4943.1616S.430.00	16x16 cm	SS. 430	5 13,68
-------------------	----------	---------	---------

## SINGLE S.S. 304

4943.1616S.304.00	16x16 cm	SS. 304	5 18,73
-------------------	----------	---------	---------

**ОДИНАРНЫЙ БУМАГОДЕРЖАТЕЛЬ СКРЫТОГО КРЕПЛЕНИЯ**  
 موزع ورق مرحاض تحت الجص مفرد

## DOUBLE S.S. 430

4944.3216S.430.00	32x16 cm	SS. 430	5 28,52
-------------------	----------	---------	---------

## DOUBLE S.S. 304

4944.3216S.304.00	32x16 cm	SS. 304	5 36,00
-------------------	----------	---------	---------

**ДВОЙНОЙ БУМАГОДЕРЖАТЕЛЬ СКРЫТОГО КРЕПЛЕНИЯ**  
 موزع ورق مرحاض تحت الجص مزدوج





# PAPER DISPENSERS

h10



## Z FOLDED TISSUE DISPENSER

Code	Size	Quality		Price \$
------	------	---------	--	----------

### S.S. 430

4922.2026P430.00	200 PCS	19x27x10 cm	S.S. 430	20	12,78
4922.3226P430.00	400 PCS	27x35x10 cm	S.S. 430	20	14,45

### S.S. 304

4922.2026P304.00	200'lük	19x27x10 cm	S.S. 304	20	20,17
4922.3226P304.00	400'lük	27x35x10 cm	S.S. 304	20	22,80

**ДЕРЖАТЕЛЬ ДЛЯ БУМАЖНЫХ ПОЛОТЕНЕЦ В**  
 Z عليه مناديل نوع طوي



## JUMBO TOILET PAPER DISPENSER

Code	Diameter	Size	Quality		Price \$
------	----------	------	---------	--	----------

### S.S. 430

4923.2712S.430.00	Ø 22	12 cm	S.S. 430	20	15,00
4923.2212S.430.00	Ø 27	12 cm	S.S. 430	20	16,67

### S.S. 304

4923.2712S.304.00	Ø 22	12 cm	S.S. 304	20	20,57
4923.2212S.304.00	Ø 27	12 cm	S.S. 304	20	22,23

**ПАЧКАХ ДЖАМБО С ПОДАЧЕЙ БУМАГИ**  
 موزع ورق مرحاض نوع جومبو منشار



## STINGY TOILET PAPER DISPENSER

Code	Size	Quality		Price \$
------	------	---------	--	----------

### S.S. 304

4923.2013S.304.00	Ø 20x13 cm	S.S. 304	12	28,90
-------------------	------------	----------	----	-------

**ОГРАНИЧЕННЫЙ**  
 CIMRI موديل



## SMILEY PAPER DISPENSER

Code	Size	Quality		Price \$
------	------	---------	--	----------

### S.S. 430

4923.2739S.430.00	27x5x39 cm	S.S. 430	20	10,00
-------------------	------------	----------	----	-------

### S.S. 304

4923.2739S.304.00	27x5x39 cm	S.S. 304	20	15,57
-------------------	------------	----------	----	-------

**БУМАГОДЕРЖАТЕЛЬ С ПОДАЧЕЙ УЛЫБКОЙ**  
 موزع ورق نوع الفم الضاحك

# PAPER DISPENSERS

h10



Code	Length		Price \$
------	--------	--	----------

## PLASTIC CHROME TOWEL DISPENSER

HD.01.4923.SK	27x22x36 cm	4	190,80
---------------	-------------	---	--------

ПЛАСТИК, ХРОМ  
بلاستيك كروم

## AUTOMATIC PLASTIC TOWEL DISPENSER

HD.01.4923.SM	27x22x36 cm	4	129,60
---------------	-------------	---	--------

АВТОМАТИЧЕСКИЙ ДОЗАТОР ПОДАЧИ ПОЛОТЕНЕЦ  
موزع مناديل أوتوماتيكي

## AUTOMATIC PLASTIC TOWEL DISPENSER

Code	Length		Price \$
------	--------	--	----------

HD.01.4923.SB	27x22x36 cm	4	122,40
---------------	-------------	---	--------

АВТОМАТИЧЕСКИЙ ДОЗАТОР ПОДАЧИ ПОЛОТЕНЕЦ  
موزع مناديل أوتوماتيكي

## PHOTOCELL HAND DRYING

Code	Length		Price \$
------	--------	--	----------

HD.05.4923.KR	57x33x50	4	561,60
---------------	----------	---	--------

ФОТОСЕНСОРНАЯ СУШИЛКА ДЛЯ РУК  
مجفف أيدي بخلايا ضوئية

## Z FOLDED DISPENSER

Code	Length	Capacity		Price \$
------	--------	----------	--	----------

HD.10.4923.SM	-	200	12	9,73
---------------	---	-----	----	------

ДИСПЕНСЕР  
موزع ذو طوابق Z

## PLASTIC PAPER DISPENSERS

Code	Length	Surface		Price \$
------	--------	---------	--	----------

HD.22.4923.SM	-	Transparent	12	12,25
---------------	---	-------------	----	-------

ЗАКРЫТЫЕ ДЕРЖАТЕЛИ ДЛЯ ТУАЛЕТНОЙ БУМАГИ ПЛАСТИКОВЫЕ  
علبة ورق مرحاض بلاستيكية موديل



# SOAP HOLDER

h10

## FOAM DISPENSER

Code	Length	Surface	Capacity		Price \$
------	--------	---------	----------	---	----------

### WHITE

HD.40.4720.BY	-	White	700 ml.	24	11,17
---------------	---	-------	---------	----	-------

### CHROME

HD.41.4720.KR	-	Chrome	700 ml.	24	15,85
---------------	---	--------	---------	----	-------

### Пенное мыло ДИСПЕНСЕР

موزع الصابون

## FOAM DISPENSER

Code	Length	Surface	Capacity		Price \$
------	--------	---------	----------	---	----------

### WHITE

HD.42.4718.BY	-	White	500 ml.	24	11,53
---------------	---	-------	---------	----	-------

### CHROME

HD.43.4718.KR	-	Chrome	500 ml.	24	15,48
---------------	---	--------	---------	----	-------

### Пенное мыло ДИСПЕНСЕР

موزع الصابون

## FOAM DISPENSER

Code	Length	Surface	Capacity		Price \$
------	--------	---------	----------	---	----------

### TRANSPARENT

HD.38.4717.SM	-	Transparent	350 ml.	24	7,20
HD.39.4717.SM	-	Transparent	650 ml.	24	8,28

### Пенное мыло ДИСПЕНСЕР

موزع الصابون

## TWIN LIQUID SOAP DISPENSER

Code	Length	Capacity		Price \$
------	--------	----------	---	----------

HD.36.4719.SM	-	350 ml + 350 ml	12	10,08
---------------	---	-----------------	----	-------

### ДОЗАТОР ДЛЯ ЖИДКОГО МЫЛА

موزع الصابون السائل

## LIQUID SOAP DISPENSER

Code	Length	Surface	Capacity		Price \$
------	--------	---------	----------	---	----------

### TRANSPARENT

HD.35.4716.SM	-	Transparent	500 ml.	24	3,25
HD.37.4716.SM	-	Transparent	1000 ml.	24	6,35

### ДОЗАТОР ДЛЯ ЖИДКОГО МЫЛА

موزع الصابون السائل



# VALVES

h10



## CONCEALED VALVE

Code	Diameter		Price \$
TM.05.8104.12	Ø 25	20	14,20
TM.07.8104.12	Ø 20	20	14,20



## CONCEALED VALVE

Code	Diameter		Price \$
TM.06.8104.12	Ø 25	20	14,20
TM.08.8104.12	Ø 20	20	14,20



## PANEL MOUNTING BRACKET

Code	Length	Surface		Price \$
2700.300.00.B	30 cm	Painted	50	6,35
2700.400.00.B	40 cm	Painted	50	6,35
2700.500.00.B	50 cm	Painted	40	6,35
2700.600.00.B	60 cm	Painted	50	6,35
2700.900.00.B	90 cm	Painted	50	6,35

МОНТАЖНЫЙ КРОНШТЕЙН ДЛЯ ПАНЕЛИ  
حامل تركيب لوحة

# PANEL RADIATOR ACCESSORIES

# h10

## PIPE SEALING BANDE SINGLE



Code	Length	Surface		Price \$
------	--------	---------	--	----------

### WHITE

2768.016.00.B	Ø 16 - Ø 17	16 cm	White	400	0,77
---------------	-------------	-------	-------	-----	------

**РОЗЕТКА ДЛЯ ТРУБ БЕЛАЯ, ЕДИНИЧНАЯ**  
 شارة إخفاء أنابيب بيضاء مفردة

### CHROME

2768.016.00.K	Ø 16 - Ø 17	16 cm	White	400	1,57
---------------	-------------	-------	-------	-----	------

**РОЗЕТКА ДЛЯ ТРУБ ХРОМИРОВАННАЯ, ЕДИНИЧНАЯ**  
 شارة إخفاء أنابيب كروم مفردة

## PIPE SEALING BADGE DOUBLE



Code	Length	Surface		Price \$
------	--------	---------	--	----------

### WHITE

2768.017.00.B	Ø 16 - Ø 17	16 cm	White	300	1,83
---------------	-------------	-------	-------	-----	------

**РОЗЕТКА ДЛЯ ТРУБ БЕЛАЯ, ДВОЙНАЯ**  
 شارة إخفاء أنابيب بيضاء مزدوجة

### CHROME

2768.017.00.K	Ø 16 - Ø 17	16 cm	Chrome	300	3,03
---------------	-------------	-------	--------	-----	------

**РОЗЕТКА ДЛЯ ТРУБ ХРОМИРОВАННАЯ, ДВОЙНАЯ**  
 شارة إخفاء أنابيب كروم مزدوجة

## PIPE SEALING BADGE



Code	Length	Surface		Price \$
------	--------	---------	--	----------

### WHITE

2768.018.00.B	Ø 16 - Ø 17	5 cm	White	300	0,53
---------------	-------------	------	-------	-----	------

**РОЗЕТКА ДЛЯ ТРУБ**  
 شارة إخفاء أنابيب

### CHROME

2768.018.00.K	Ø 16 - Ø 17	5 cm	Chrome	300	1,25
---------------	-------------	------	--------	-----	------

## WALL TRANSITION PIPE



Code	Length	Surface		Price \$
------	--------	---------	--	----------

5201.00910.03.2	3/4	Gray	400	0,33
-----------------	-----	------	-----	------

**НАСТЕННАЯ ПЕРЕХОДНАЯ ТРУБА**

# CERAMIC TILE PROFILES

h10

10 MM



## STAINLESS BORDER

Code	Thickness	Length		Price \$
<b>SS 304</b>				
PB.01.304P10	0.50 mm	244 cm	100	3,25
<b>SS 201</b>				
PB.19.201P10	0.50 mm	244 cm	100	2,97
<b>SS 430</b>				
PB.37.430P10	0.50 mm	244 cm	100	2,27

15 MM



## STAINLESS BORDER

Code	Thickness	Length		Price \$
<b>SS 304</b>				
PB.02.304P15	0.50 mm	244 cm	100	3,78
<b>SS 201</b>				
PB.20.201P15	0.50 mm	244 cm	100	3,43
<b>SS 430</b>				
PB.38.430P15	0.50 mm	244 cm	100	2,62

2V3 MM



## STAINLESS BORDER

Code	Thickness	Length		Price \$
<b>SS 304</b>				
PB.03.304P23	0.50 mm	244 cm	75	4,58
<b>SS 201</b>				
PB.21.201P23	0.50 mm	244 cm	75	4,13
<b>SS 430</b>				
PB.39.430P23	0.50 mm	244 cm	75	3,17

304, 201 and 430 quality stainless steel. Suitable for floor and wall use. It is used in different colors and different kinds of ceramic passages on the walls and floors which add beauty to the ceramics. With the advantage of being a manufacturer, we are not only produce standard length of products, but also we can produce length suitable for your project.

# CERAMIC TILE PROFILES

h10

30 MM



## STAINLESS BORDER

Code	Thickness	Length		Price \$
------	-----------	--------	---	----------

### SS 304

PB.04.304P30	0.50 mm	244 cm	55	5,25
--------------	---------	--------	----	------

### SS 201

PB.22.201P30	0.50 mm	244 cm	55	4,72
--------------	---------	--------	----	------

### SS 430

PB.40.430P30	0.50 mm	244 cm	55	3,67
--------------	---------	--------	----	------

40 MM



## STAINLESS BORDER

Code	Thickness	Length		Price \$
------	-----------	--------	---	----------

### SS 304

PB.05.304P40	0.50 mm	244 cm	40	6,83
--------------	---------	--------	----	------

### SS 201

PB.23.201P40	0.50 mm	244 cm	40	6,10
--------------	---------	--------	----	------

### SS 430

PB.41.430P40	0.50 mm	244 cm	40	4,35
--------------	---------	--------	----	------

50 MM



## STAINLESS BORDER

Code	Thickness	Length		Price \$
------	-----------	--------	---	----------

### SS 304

PB.06.304P50	0.50 mm	244 cm	30	8,02
--------------	---------	--------	----	------

### SS 201

PB.24.201P50	0.50 mm	244 cm	30	7,15
--------------	---------	--------	----	------

### SS 430

PB.42.430P50	0.50 mm	244 cm	30	5,08
--------------	---------	--------	----	------

304, 201 and 430 quality stainless steel. Suitable for floor and wall use. It is used in different colors and different kinds of ceramic passages on the walls and floors which add beauty to the ceramics. With the advantage of being a manufacturer, we are not only produce standard length of products, but also we can produce length suitable for your project.

# CERAMIC TILE PROFILES

h10

10 MM



## STAINLESS BORDER

Code	Thickness	Length		Price \$
------	-----------	--------	---	----------

### SS 304

PB.07.304G:10	0.50 mm	244 cm	100	5,33
---------------	---------	--------	-----	------

### SS 201

PB.24.201G:10	0.50 mm	244 cm	100	4,05
---------------	---------	--------	-----	------

15 MM



## STAINLESS BORDER

Code	Thickness	Length		Price \$
------	-----------	--------	---	----------

### SS 304

PB.08.304G:15	0.50 mm	244 cm	100	6,37
---------------	---------	--------	-----	------

### SS 201

PB.26.201G:15	0.50 mm	244 cm	100	4,78
---------------	---------	--------	-----	------

23 MM

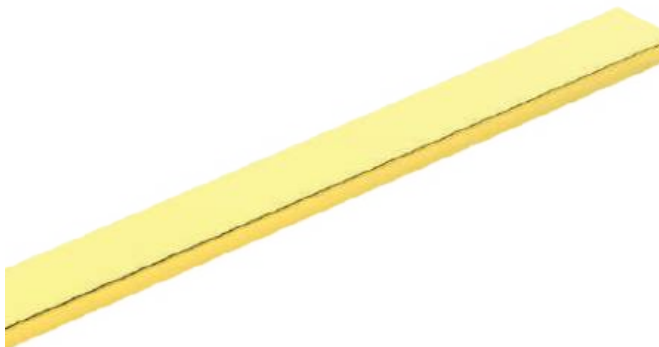

## STAINLESS BORDER

Code	Thickness	Length		Price \$
------	-----------	--------	---	----------

### SS 304

PB.09.304G:23	0.50 mm	244 cm	75	8,02
---------------	---------	--------	----	------

### SS 201

PB.27.201G:23	0.50 mm	244 cm	75	5,95
---------------	---------	--------	----	------

304, 201 and 430 quality stainless steel. Suitable for floor and wall use. It is used in different colors and different kinds of ceramic passages on the walls and floors which add beauty to the ceramics. With the advantage of being a manufacturer, we are not only produce standard length of products, but also we can produce length suitable for your project.



# CERAMIC TILE PROFILES

h10

30 MM



## STAINLESS BORDER

Code	Thickness	Length		Price \$
------	-----------	--------	---	----------

### SS 304

PB.II.304G.30	0.50 mm	244 cm	55	9,47
---------------	---------	--------	----	------

### SS 201

PB.28.201G.30	0.50 mm	244 cm	55	6,98
---------------	---------	--------	----	------

40 MM

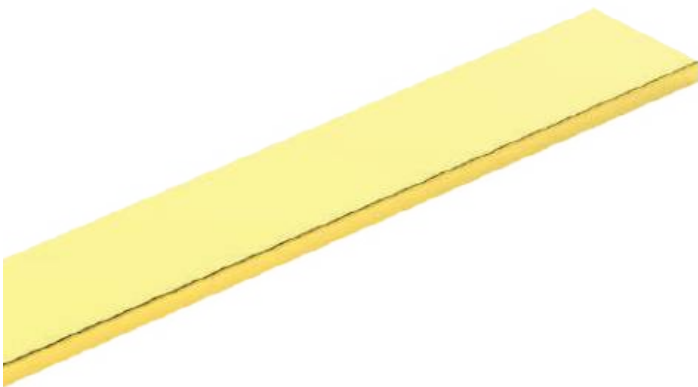

## STAINLESS BORDER

Code	Thickness	Length		Price \$
------	-----------	--------	---	----------

### SS 304

PB.II.304G.40	0.50 mm	244 cm	40	11,55
---------------	---------	--------	----	-------

### SS 201

PB.29.201G.40	0.50 mm	244 cm	40	8,45
---------------	---------	--------	----	------

50 MM

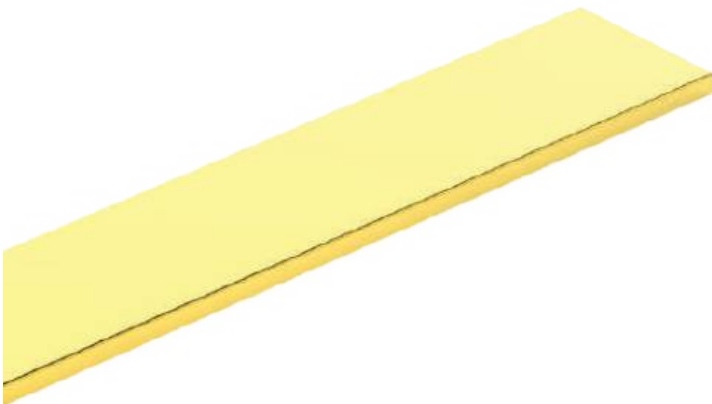

## STAINLESS BORDER

Code	Thickness	Length		Price \$
------	-----------	--------	---	----------

### SS 304

PB.II.304G.50	0.50 mm	244 cm	30	13,67
---------------	---------	--------	----	-------

### SS 201

PB.30.201G.50	0.50 mm	244 cm	30	9,95
---------------	---------	--------	----	------

304, 201 and 430 quality stainless steel. Suitable for floor and wall use. It is used in different colors and different kinds of ceramic passages on the walls and floors which add beauty to the ceramics. With the advantage of being a manufacturer, we are not only produce standard length of products, but also we can produce length suitable for your project.

# CERAMIC TILE PROFILES

h10

10 MM



## STAINLESS BORDER

Code	Thickness	Length		Price \$
------	-----------	--------	---	----------

### SS 304

PB.I3.304B.10	0.50 mm	244 cm	100	6,27
---------------	---------	--------	-----	------

### SS 201

PB.3I.201B.10	0.50 mm	244 cm	100	4,40
---------------	---------	--------	-----	------

15 MM



## STAINLESS BORDER

Code	Thickness	Length		Price \$
------	-----------	--------	---	----------

### SS 304

PB.I4.304B.15	0.50 mm	244 cm	100	7,53
---------------	---------	--------	-----	------

### SS 201

PB.32.201B.15	0.50 mm	244 cm	100	5,20
---------------	---------	--------	-----	------

23 MM



## STAINLESS BORDER

Code	Thickness	Length		Price \$
------	-----------	--------	---	----------

### SS 304

PB.I5.304B.23	0.50 mm	244 cm	75	9,53
---------------	---------	--------	----	------

### SS 201

PB.33.201B.23	0.50 mm	244 cm	75	6,48
---------------	---------	--------	----	------

304, 201 and 430 quality stainless steel. Suitable for floor and wall use. It is used in different colors and different kinds of ceramic passages on the walls and floors which add beauty to the ceramics. With the advantage of being a manufacturer, we are not only produce standard length of products, but also we can produce length suitable for your project.

# CERAMIC TILE PROFILES

h10

30 MM

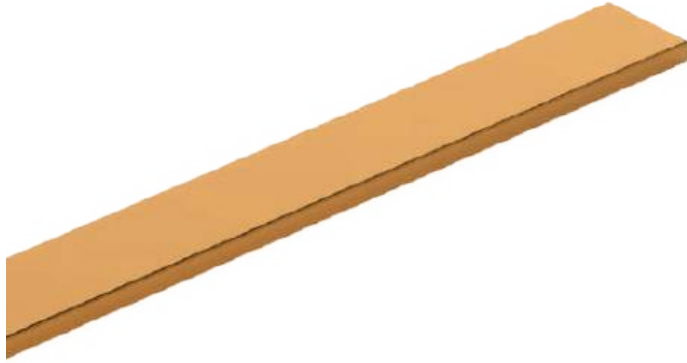

## STAINLESS BORDER

Code	Thickness	Length		Price \$
------	-----------	--------	---	----------

### SS 304

PB.16.304B.30	0.50 mm	244 cm	55	11,30
---------------	---------	--------	----	-------

### SS 201

PB.34.201B.30	0.50 mm	244 cm	55	7,63
---------------	---------	--------	----	------

40 MM

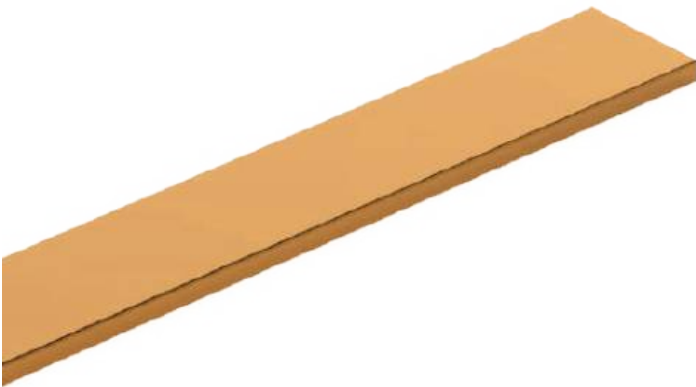

## STAINLESS BORDER

Code	Thickness	Length		Price \$
------	-----------	--------	---	----------

### SS 304

PB.17.304B.40	0.50 mm	244 cm	40	13,83
---------------	---------	--------	----	-------

### SS 201

PB.35.201B.40	0.50 mm	244 cm	40	9,28
---------------	---------	--------	----	------

50 MM



## STAINLESS BORDER

Code	Thickness	Length		Price \$
------	-----------	--------	---	----------

### SS 304

PB.18.304B.50	0.50 mm	244 cm	30	16,40
---------------	---------	--------	----	-------

### SS 201

PB.36.201B.50	0.50 mm	244 cm	30	10,80
---------------	---------	--------	----	-------

304, 201 and 430 quality stainless steel. Suitable for floor and wall use. It is used in different colors and different kinds of ceramic passages on the walls and floors which add beauty to the ceramics. With the advantage of being a manufacturer, we are not only produce standard length of products, but also we can produce length suitable for your project.

**304 & 201 quality stainless profiles. Suitable for use in floors and walls. The beauty of ceramic floor and wall and floor ceramics are commonly used in different colors and different kinds of transition.**

You have the advantage that gave us our producers not only in standard sizes, we are able to manufacture products in accordance with your project and your product.

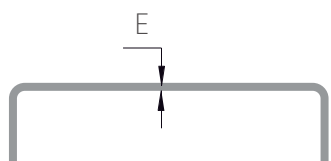

Code	W	L	H	E
	244	10	9	0.5
15P201	244	15	9	0.5
	244	23	9	0.5
30P201	244	30	9	0.5
	244	40	9	0.5
50P201	244	50	9	0.5

# CERAMIC TILE PROFILES

h10

30 MM



## LILA STAINLESS BORDER

Code	Thickness	Length		Price \$
------	-----------	--------	---	----------

### SS 304

PB.46.304P30	0.50 mm	244 cm	55	6,17
--------------	---------	--------	----	------

### SS 201

PB.43.201P30	0.50 mm	244 cm	55	5,52
--------------	---------	--------	----	------

30 MM



## LILA STAINLESS BORDER

Code	Thickness	Length		Price \$
------	-----------	--------	---	----------

### SS 304

PB.47.304G.30	0.50 mm	244 cm	55	9,23
---------------	---------	--------	----	------

### SS 201

PB.44.201G.30	0.50 mm	244 cm	55	6,82
---------------	---------	--------	----	------

30 MM

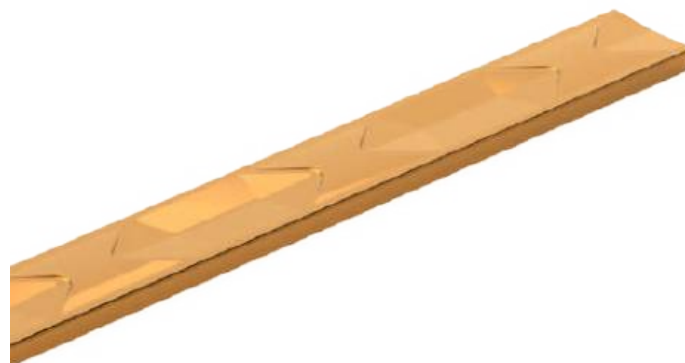

## LILA STAINLESS BORDER

Code	Thickness	Length		Price \$
------	-----------	--------	---	----------

### SS 304

PB.48.304B.30	0.50 mm	244 cm	55	12,30
---------------	---------	--------	----	-------

### SS 201

PB.45.201B.30	0.50 mm	244 cm	55	7,47
---------------	---------	--------	----	------

304, 201 and 430 quality stainless steel. Suitable for floor and wall use. It is used in different colors and different kinds of ceramic passages on the walls and floors which add beauty to the ceramics. With the advantage of being a manufacturer, we are not only produce standard length of products, but also we can produce length suitable for your project.

# CERAMIC TILE PROFILES

h10

10 MM



## OPEN TYPE SQUARE

Code	Thickness	Length		Price \$
------	-----------	--------	---	----------

### SS 304

PB.81.304P10	0.50 mm	244 cm	60	7,57
--------------	---------	--------	----	------

### SS 201

PB.80.201P10	0.50 mm	244 cm	60	6,85
--------------	---------	--------	----	------

10 MM

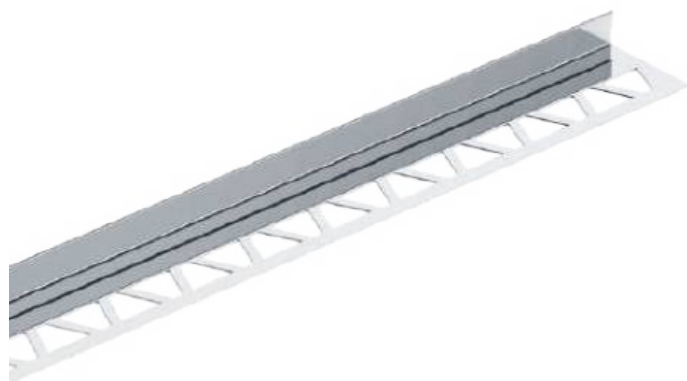

## 90° STRAIGHT BORDER

Code	Thickness	Length		Price \$
------	-----------	--------	---	----------

### SS 304

PB.83.304P10	0.50 mm	244 cm	60	7,57
--------------	---------	--------	----	------

### SS 201

PB.82.201P10	0.50 mm	244 cm	60	6,85
--------------	---------	--------	----	------

12 MM



## OPEN TYPE OVAL BORDER

Code	Thickness	Length		Price \$
------	-----------	--------	---	----------

### SS 304

PB.89.304P12	0.50 mm	244 cm	60	7,57
--------------	---------	--------	----	------

### SS 201

PB.88.201P12	0.50 mm	244 cm	60	6,85
--------------	---------	--------	----	------

304, 201 and 430 quality stainless steel. Suitable for floor and wall use. It is used in different colors and different kinds of ceramic passages on the walls and floors which add beauty to the ceramics. With the advantage of being a manufacturer, we are not only produce standard length of products, but also we can produce length suitable for your project.

# CERAMIC TILE PROFILES

h10

10 MM



## INSIDE CORNER BORDER

Code	Thickness	Length		Price \$
------	-----------	--------	---	----------

### SS 304

PB.85.304R10	0.50 mm	244 cm	60	7,57
--------------	---------	--------	----	------

### SS 201

PB.84.201R10	0.50 mm	244 cm	60	6,85
--------------	---------	--------	----	------

10 MM

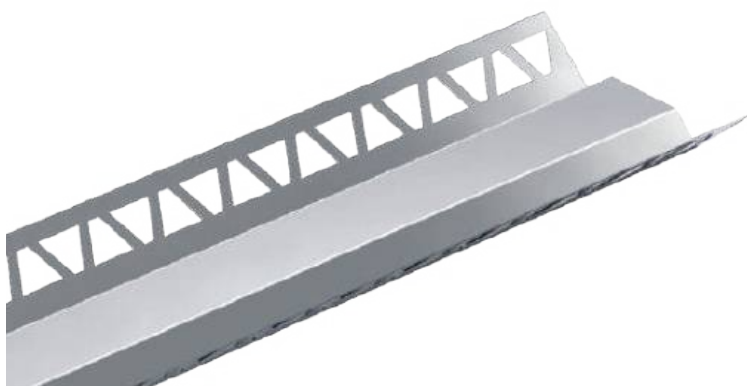

## DOUBLE CORNER BORDER

Code	Thickness	Length		Price \$
------	-----------	--------	---	----------

### SS 304

PB.87.304R10	0.50 mm	244 cm	30	14,27
--------------	---------	--------	----	-------

### SS 201

PB.86.201R10	0.50 mm	244 cm	30	12,68
--------------	---------	--------	----	-------

304, 201 and 430 quality stainless steel. Suitable for floor and wall use. It is used in different colors and different kinds of ceramic passages on the walls and floors which add beauty to the ceramics. With the advantage of being a manufacturer, we are not only produce standard length of products, but also we can produce length suitable for your project.

